

# LEDZEP™ PUNCH

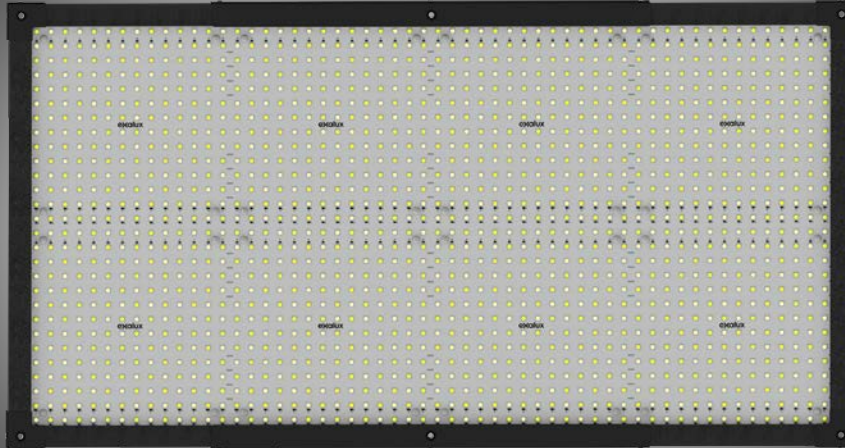

**GET READY TO BE DAZZLED**

# NEW CONCEPT | NEW STANDARD

**LEDZEP™ PUNCH** is the **ultra-bright** LED panel that sets a new standard for the film industry.

**LEDZEP™ PUNCH** is thin, lightweight, robust, versatile and fully tunable from 2700K to 6500K.

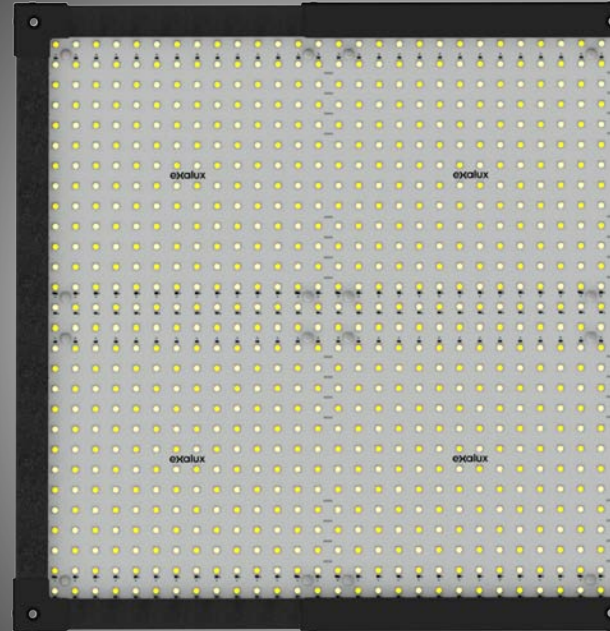

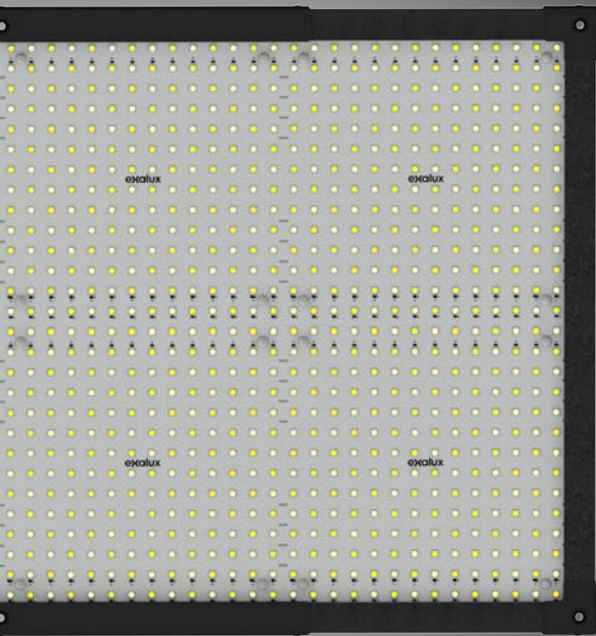

WWW.EXALUX.EU

**LEDZEP  
PUNCH  
1X4TW2765**

**24V . 175W**

USE WITH EXALUX OR  
USE WITH EXALUX EXTENSION CABLE



exalux

LEDZEP

2700K | 6500K

100.0

⚠ DO NOT BEND OR FOLD

⚠ WITH EQUALIZER DIMMER ONLY  
WITH EQUALIZ EXTENSION CABLE DIMM. SW ⚠

# FOCUSED BEAM | MORE ILLUMINANCE

With LEDZEP™ PUNCH, you can get up to 3 times more illuminance thanks to our amazing Punch LED Engine.

The focus beam allows a maximum of the luminous flux issued from the emitters to be used to light up the subject, whereas on standard 120° LED based panels, a part of the luminous flux is lost due to the wide angle. With PUNCH concept, you get more illuminance even when the light is diffused through a diffusion cloth.

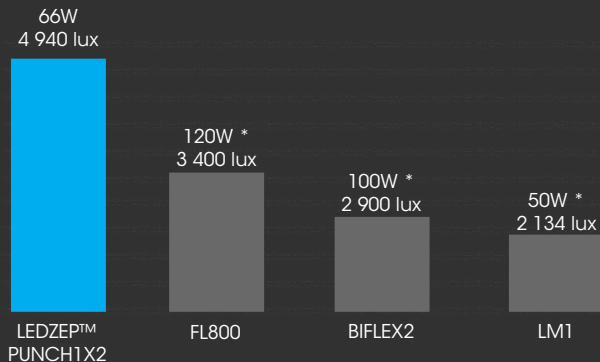

ILLUMINANCE @6500K / @1m  
(\* )manufacturer's data

120° SMD LED PANEL

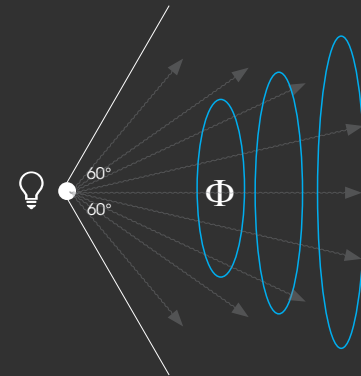

LEDZEP PUNCH WITH FOCUSED BEAM

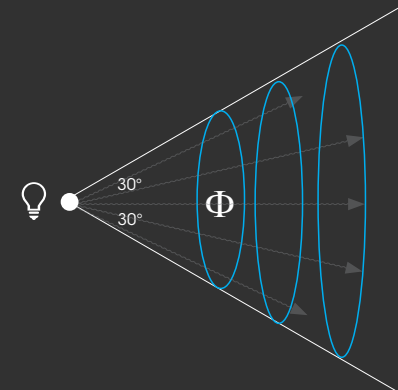

# NEW EMITTERS | PERFECT COLOUR RENDITION

Here at EXALUX, we cultivate «the French art of light». We work with light as a noble material with care and passion.

6500K

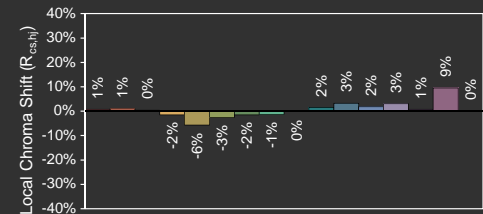
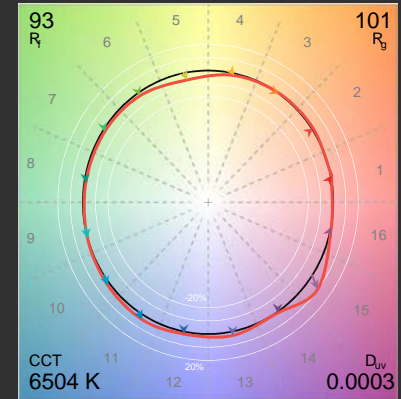
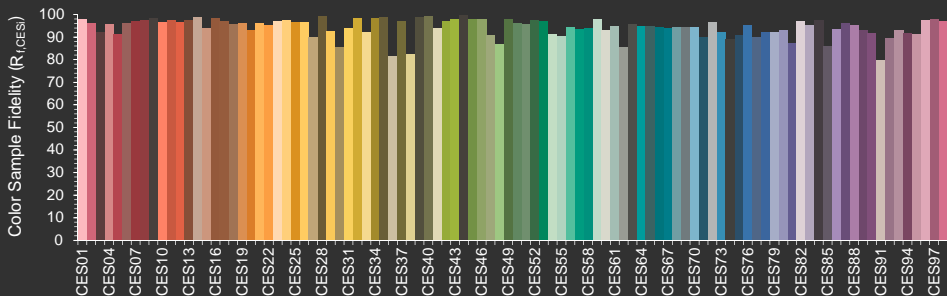

# ONLY WHITE | <sup>BUT</sup> THE RICHEST WHITE

We have selected the finest LED bin to create our powerful Tunable White LED Engine. It delivers a rich and variable white from 2700K to 6500k with a very low chromatic shift.

## 2700K

98

TLCI

96

Ra

94

TM30-18

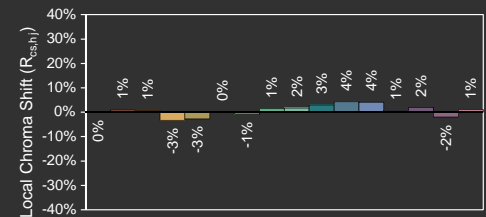
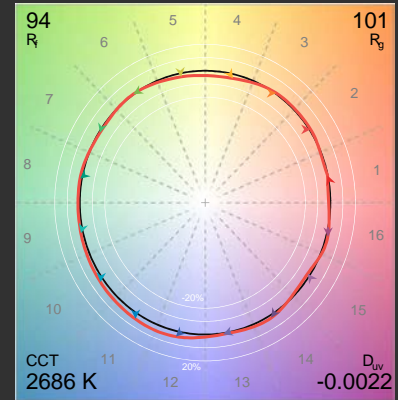
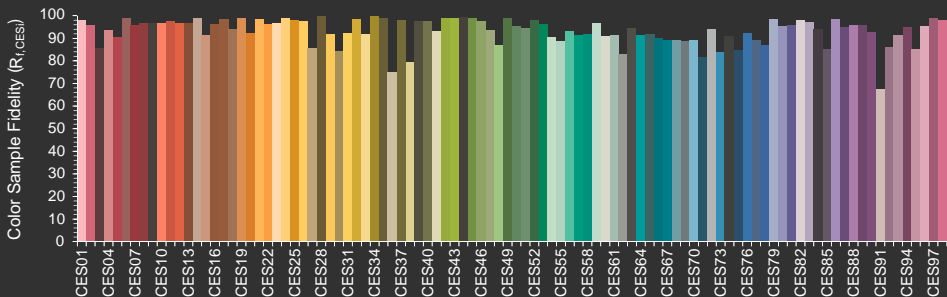

# KEY FEATURES | BENEFITS

## LOW VOLTAGE INPUT

24VDC,  
NEUTRIK XLR4.

## EASY TO ACCESSORIZE

Hook & loop fastener  
for easily and quickly  
mounted accessories.

## RIGGING & LINKING SYSTEM

Threaded holes can  
be used for rigging  
or connecting  
panels together.

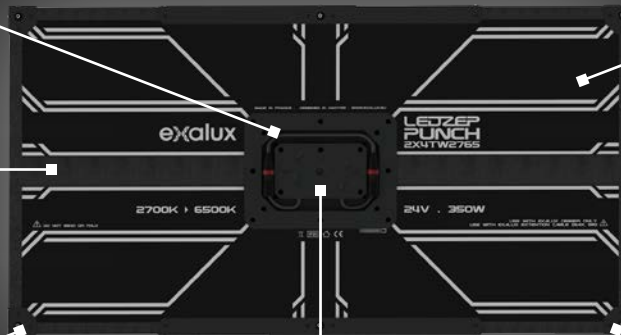

## LIGHTWEIGHT AND ROBUST

Rugged body made  
of strong material.

## INDUSTRY STANDARD COMPLIANT

Fully compatible with most  
removable mounting plates.

## SHOCK PROOF

Corner and edge  
protection to  
prevent damage  
when falling.



### PERFECT DIMMING

4KHz ▶ 32KHz PWM  
compliant.

### HIGH ILLUMINANCE

High power LED,  
60° emission angle.

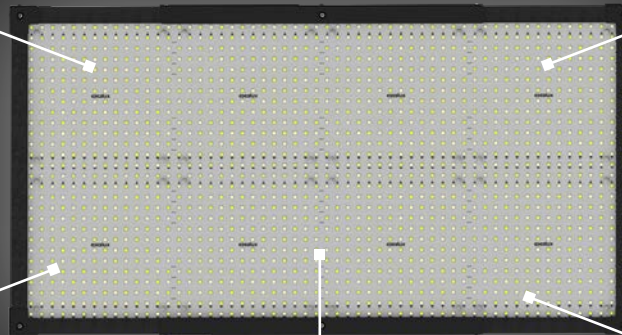

### HIGH COLOUR RENDERING

TLCI : 99,  
Ra : 97,  
TLC30-18 : 94.

### HIGH PERFORMANCE LED ENGINE

Tunable White : 2700 ▶ 6500K,  
Low duv :  
-2.60<sup>-03</sup> ± 5% @2700K  
2.89<sup>-05</sup> ± 5% @6500K

### HIGH EFFICIENCY

Constant current driving circuits :  
Ensure CCT and flux consistency  
to get more flux with less power.

# A LEDZEPT™ PUNCH | FOR ANY USE



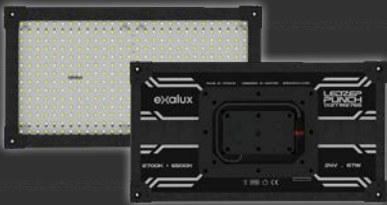

**LEDZEP PUNCH**  
1X2TW2765



**LEDZEP PUNCH**  
1X4TW2765

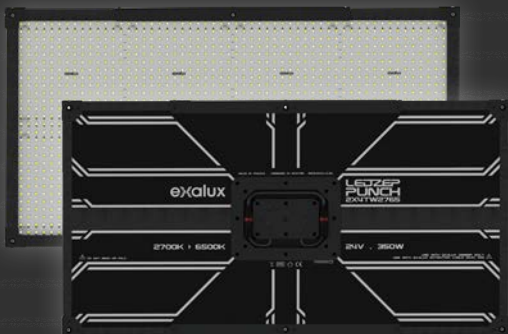

**LEDZEP PUNCH**  
2X4TW2765





# LEDZEP PUNCH 1x2TW2765

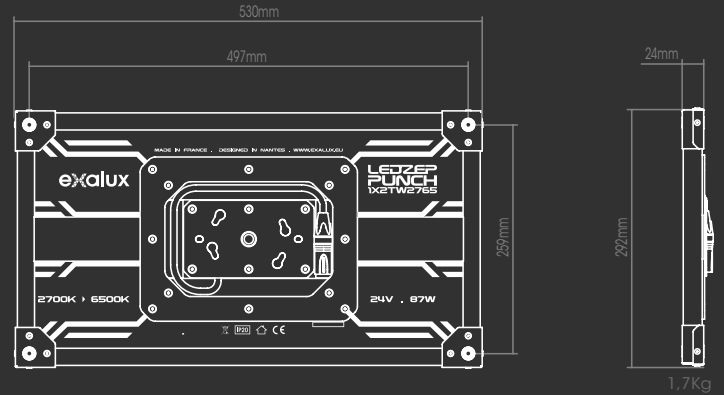
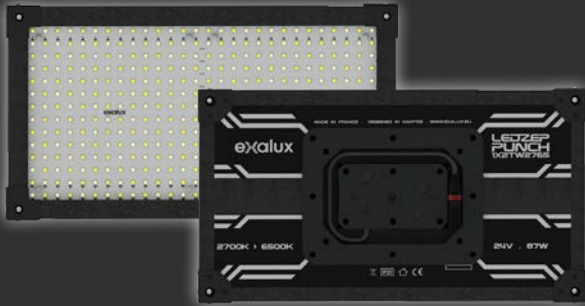

## ELECTRICAL DATA

Input Voltage (PWM)	24VDC
Power Consumption	
@2700K	86W
@6500K	66W

## COMPLIANT DIMMERS

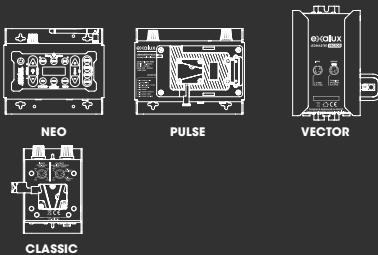

## PHOTOMETRIC DATA

CCT	2 700K ± 5%	6 500K ± 5%
Flux (lm)	6 175 ± 5%	5 848 ± 5%
duv	-2.60 <sup>-03</sup> ± 5%	2.89 <sup>-05</sup> ± 5%
Efficiency (lm/w)	69,13 ± 5%	86,52 ± 5%
Angle / Fwhm (°)	60	60
Colour rendering		
Ra	96	97
R9	98	87
R13	95	97
R15	97	94
TLCI	99	99
TM30-18	94	93

## ILLUMINANCE (LUX)

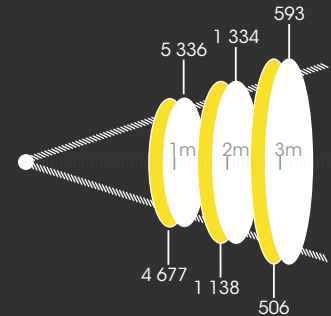

# LEDZEP PUNCH 1X4TW2765

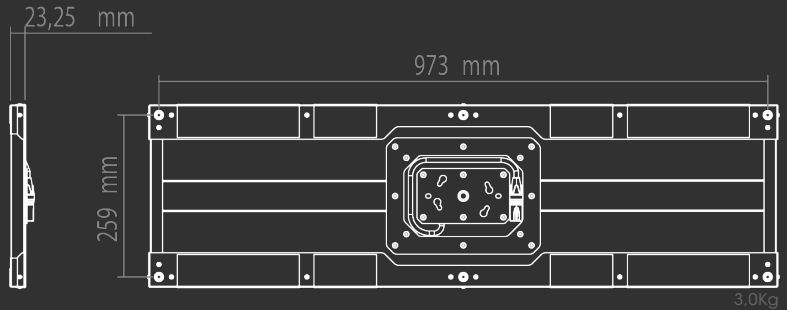

## ELECTRICAL DATA

Input Voltage (PWM)	24VDC
Power Consumption	
@2700K	173W
@6500K	132W

## COMPLIANT DIMMER



NEO

## PHOTOMETRIC DATA

CCT	2 700K ± 5%	6 500K ± 5%
Flux (lm)	12 350 ± 5%	11 696 ± 5%
duv	-2.60 <sup>03</sup> ± 5%	2.89 <sup>05</sup> ± 5%
Efficiency (lm/w)	69,13 ± 5%	86,52 ± 5%
Angle / Fwhm (°)	60	60
Colour rendering		
Ra	96	97
R9	98	87
R13	95	97
R15	97	94
TLCI	99	99
TM30-18	94	93

## ILLUMINANCE (LUX)

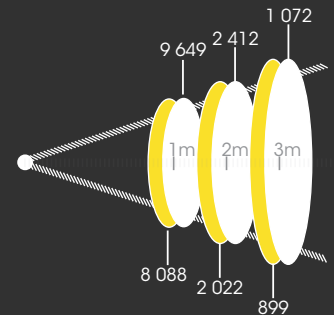

# LEDZEP PUNCH 2X4TW2765

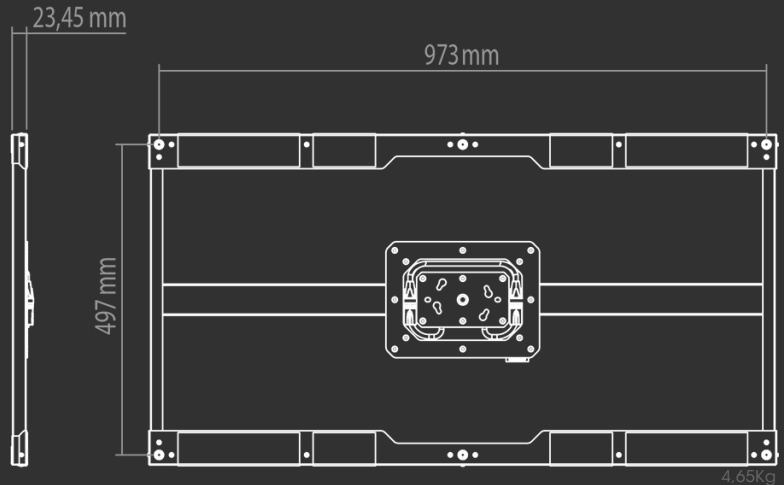
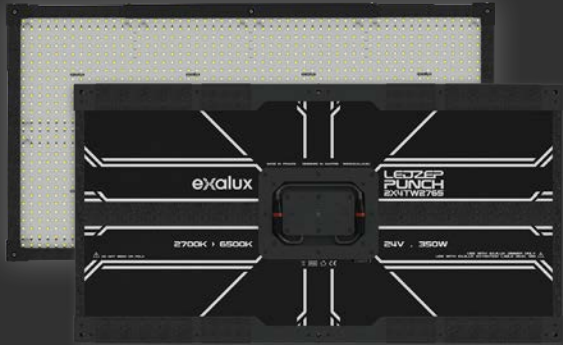

## ELECTRICAL DATA

Input Voltage (PWM)	24VDC
Power Consumption	
@2700K	345W
@6500K	265W

## COMPLIANT DIMMER



NEO

## PHOTOMETRIC DATA

CCT	2 700K ± 5%	6 500K ± 5%
Flux (lm)	24 704 ± 5%	23 392 ± 5%
duv	-2.60 <sup>-03</sup> ± 5%	2.89 <sup>-05</sup> ± 5%
Efficiency (lm/w)	69,13 ± 5%	86,52 ± 5%
Angle / Fwhm (°)	60	60
Colour rendering		
Ra	96	97
R9	98	87
R13	95	97
R15	97	94
TLCI	99	99
TM30-18	94	93

## ILLUMINANCE (LUX)

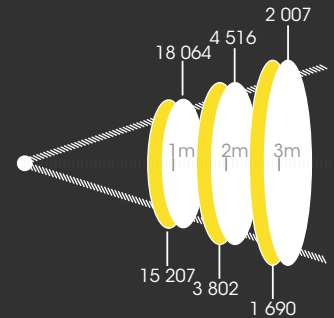

# SHAPE YOUR LIGHT | GET THE FULL LIGHT CONTROL

Shaping light has never been easier thanks to the wide range of DoPchoice and ZEPELIN™ diffusers. As easy as 1,2,3. DoPchoice SNAPGRIDS® mounts on the front of a SNAPBOX® or a ZEPELIN™ diffuser to control the spread of light.



SNAPBOX® by  
DoPchoice®

SNAPGRID® by  
DoPchoice®



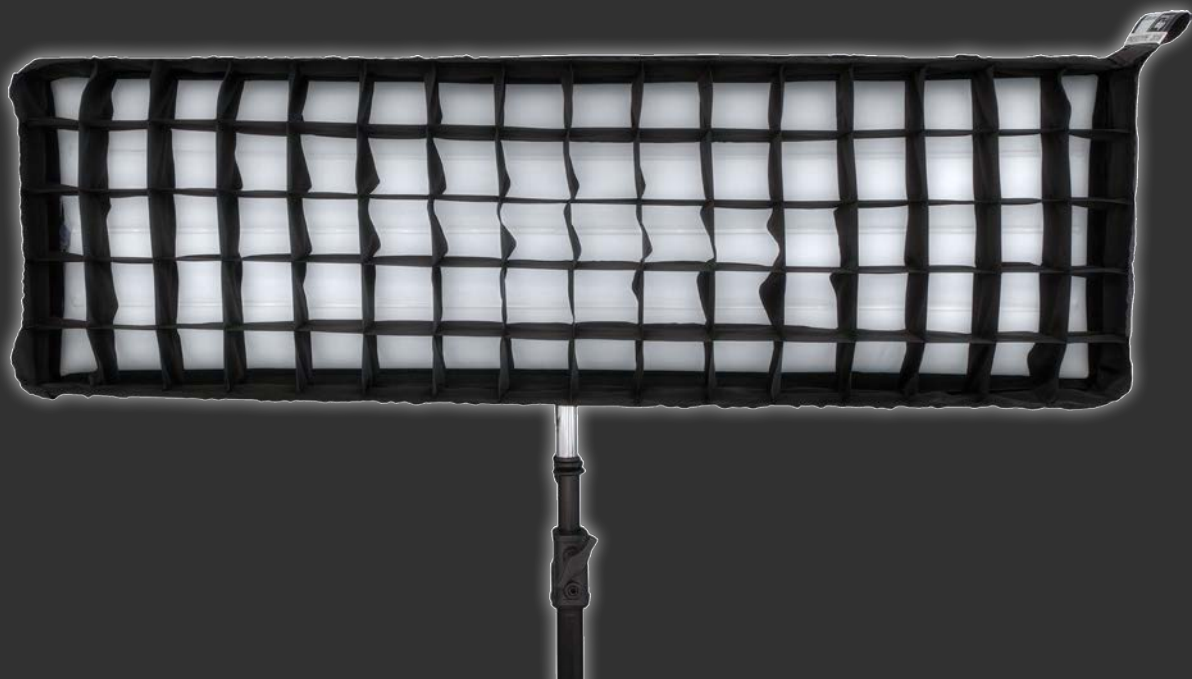

# ACCESSORIES

## CLAMPS

---



### TWIST-ON PLATE

REF : ACC.007.001

Mounting plate for attaching fixtures to a griphead. Features a steel ball well-welded with a 10mm knurled rod for maximum strength.



### SK MOUNTING PLATE

REF : ACC.007.014

Mounting plate for attaching fixtures to any grip equipment that come with 5/8» (16mm) stud. Features a double socket arm with balls and a central knob ensuring a safe lock with only one clamping action.



### GOOSE-NECK PLATE

REF : ACC.007.015

Mounting plate for attaching fixtures to any standard 16mm spigot. Features a steel ball well-welded with the offset adapter for maximum strength and balances the fixture's weight on the center of the stand.

## CABLES

---



### XLR4 EXT. CABLE (2M)

REF : COR.001.021,

2m Extension Cable,  
NEUTRIK XLR4 male to XLR4 Female.



### XLR4 EXT. CABLE (5M)

REF : COR.001.023,

5m Extension Cable,  
NEUTRIK XLR4 male to XLR4 Female.



### POWER CABLE (1,8m)

REF: COR.000.002 (EU), COR.000.003 (UK)

COR.000.004 (JP/US),

COR.000.007 (AU/CN)

1,8m powerCON TRUE1 cable.

## BAGS

---



### LEDZEP 1X2 BAG

REF : EMB.005.003  
Up to 2pcs per bag.



### LEDZEP 1X4 BAG

REF : EMB.005.001  
Up to 2pcs per bag.



### LEDZEP 2X4 BAG

REF : EMB.005.002  
Up to 2pcs per bag.

## OTHERS

---



### SLING

REF : EMB.007.016  
Aluminium Sling,  
Cable length : 250mm.

# LEDZEP™ | KITS

## LEDZEP 2X4 | KIT

REF : LZP.103.001



extension cable  
(5M)



extension cable  
(2M)



Power cable  
(1,8M)



DoPchoice®  
SNAPBOX® & diffuser



LEDMASTER™ NEO



400W PSU



Twist-On plate

# LEDZEP 1X4 | KIT

REF : LZP.100.001



extension cable  
(5M)



extension cable  
(2M)



Power cable  
(1.8M)



DoPchoice®  
SNAPBOX® & diffuser



LEDMASTER™ NEO



200W PSU



Twist-On plate

# LEDZEP 1X2 | KIT

REF : LZP.101.001



Extension cable  
(5m)



60W PSU



DoPchoice®  
SNAPBOX® & diffuser



LEDMASTER™ PULSE



SK mounting plate

# DIMMERS

In the EXALUX universe, you can use our dimmers with any head as long as the wattage is matched. That's a real benefit on set !

Our LEDMASTER dimmers are famous for the smooth dimming and the fine tuning.

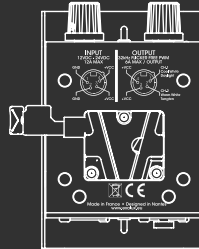

## CLASSIC

REF : LMA.001.001  
144W max output,  
Analog control,  
Tunable/dual channel mode.

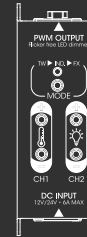

## STICK FX

REF : LMA.201.002,  
72W max output,  
Analog control,  
Tunable/dual channel / FX mode .

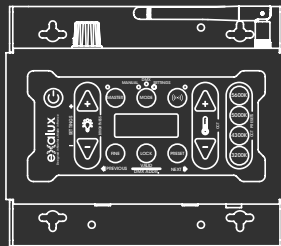

## NEO

REF : LMA.001.012  
240W+240W max output,  
DMX512,  
RDM ANSI E1.20,  
CRMX by LumenRadio™.

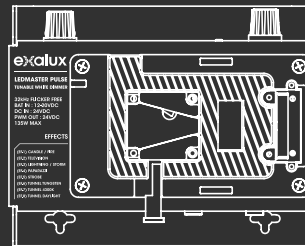

## PULSE

REF : LMA.001.007  
135W max output,  
DMX512,  
V-lock input.

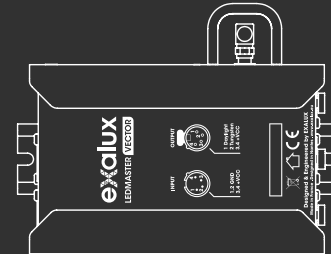

## VECTOR

REF : LMA.001.010  
120W+120W max output,  
DMX512,  
RDM ANSI E1.20,  
CRMX by LumenRadio™,  
X-LINK remote Input (RJ45).

# POWER

We have created EXAWATT™, to give you the best energy to power your LEDZEP!

EXAWATT™ range is made of rugged power supplies and a battery-powered standalone station.

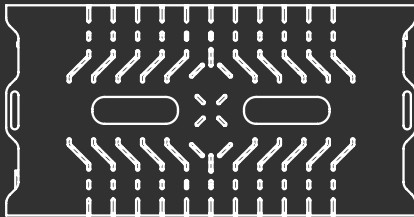

## PSU-400-24

REF : PSU.001.048  
24VDC / 400W / 16.7A,  
Rugged Power Supply,  
110-230VAC / 6.30A max input,  
powerCON input & output,  
3/8" adapter + aluminium sling.

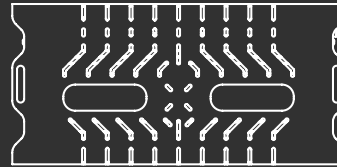

## PSU-200-24

REF : PSU.001.047  
24VDC / 200W / 8.3A,  
Rugged Power Supply,  
110-230VAC / 2.5A max input,  
powerCON input & output,  
3/8" adapter + Aluminium sling.

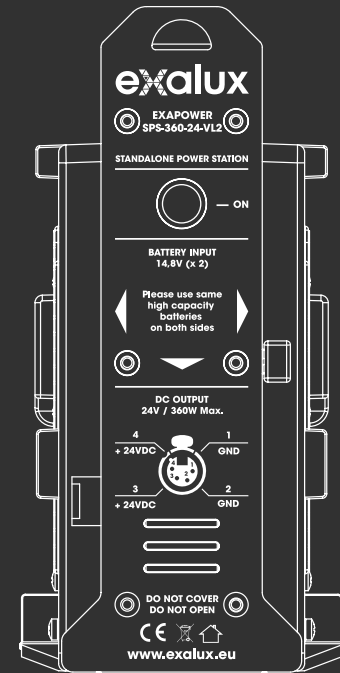

## SPS-360-24-VL2

REF : PWR.024.004  
24VDC / 360W/15A,  
StandAlone Power Station,  
10-17VDC battery input (v-lock),  
XLR4 female output,  
3/8" adapter + aluminium sling.

# exalux

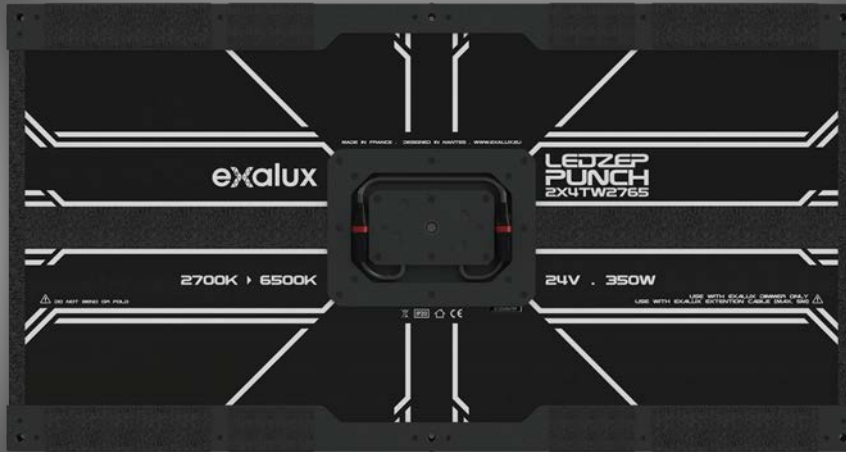

[exalux.eu](http://exalux.eu)

EXALUX, 1 rue de la Noë 44322 Nantes Cedex 3 France | +33 9 72 45 70 43 | [contact@exalux.eu](mailto:contact@exalux.eu)