



CATALOG

2020



INVENTIONS FOR YOU.

Astera is a German hardware, software and manufacturing specialist. Since the mid-2000s, Astera has been producing battery powered, remote controlled LED lights. In 2007 Astera moved its factory from Germany to Shenzhen/China, the worldwide hub of LED technology and electronic innovation. By now, this factory has been extended to more than 5000 sqm and is run by an international team of specialists.

True to its roots, Astera only manufactures battery-powered lights and accessories. Over the years the company kept adding features and new technologies to its lights. A range of battery spotlights has been used to illuminate numerous world-famous events.

In 2018, Astera noticed an increasing demand from the media industry for portable lights that can be used to shoot movies, commercials, music videos etc and decided to build a product dedicated for this market. Astera got in touch with gaffers and cinematographers and with their help developed the award-winning Titan Tube.

For the coming years, several unique products are under development. Astera loves to listen to customers and with their help develop well thought-through products that help customers to express their creativity and that professionals enjoy using.

N. Ernst

Norbert Ernst
CEO, Astera

INDEX

INTRO 2 - 5

100% Wireless | Astera System | Features

TUBES 6 - 15

Helios Tube | Titan Tube | Hyperion Tube | Pixel Tube

SPOTLIGHTS 16 - 25

AX5 | AX10 | AX3

NEW PRODUCTS 26 - 31

AX2 PixelBar | NYX Bulb

APP + ART7 32 - 35

Astera App | Astera Box



©Knomad Colab - www.knomadcolab.com - #KnomadColab



©Marcus Hartmann - photo-hartmann.de - Zürich Open Air

100% WIRELESS



Max. 20h

Advanced battery technology and control lets you set the battery runtime to up to 20 hours. You can be sure that your Astera fixture won't run out of juice before your production is finished.



App

AsteraApp offers intuitive and fast control of complex lighting setups and is also used to change DMX settings of the lights as well as monitor them out of a distance.



Wireless DMX

Each of our lights has a CRMX module from Lumen-Radio built-in, offering you the most reliable DMX technology on the market.



IP65

All Astera fixtures come in IP65 waterproof housings to make sure you can use them outdoors without worries.

THE ASTERA SYSTEM



Set up Lights

Set up your lights conveniently out of the distance. Adjust DMX settings on one or several lights. After your job, do a master reset.

Monitor Lights

Check your lights while operating them. View battery status, settings, targeted lights and get informed if a light is being moved.

Control Lights

Send effects and colors to your lights. Choose which lights you want to target. Save programs for quick launch later.

Wireless DMX

The AsteraBox works as a wireless DMX transmitter with CRMX technology, just connect it with the included XLR adapter.

Compatible

Astera Lights can be controlled together by CRMX and W-DMX (limited compatibility) so you can use them together with other wireless lights.

UHF

2.4 GHz



AsteraApp



AsteraBox



DMX Console

WHAT MAKES OUR LIGHTS THE NUMBER ONE CHOICE?



Max. 20h



App



Wireless DMX



IP65



Talkback+

Detect all available lights, set them up, check their status, configure DMX addresses and DMX profiles.



Seamless Runtime

Set the length of your event and be sure that your lights won't run out while still getting the maximum brightness.



TruColor Calibration

Individually calibrated lights lead to 100% color consistency and exact color reproduction of color temperatures and standard filter gels.



Effects

Quickly create programs out of colors and effects. Turn multiple programs and lights into scenes.



Flicker Free

Scrambled PWM technology to avoid flickering when filming.



Green/Magenta correction

Adjust green/magenta during content creation to reduce post-production work.



Scheduled Stand-by

Switch lights into power-saving standby and schedule them to wake up when the event starts.



Dynamic Power-boost

This exclusive feature makes the light able to display the maximum brightness at all time and intensify non-white colors.



Emergency Light

Switches to white light when AC power is cut to keep your event save.



Anti-theft

The lights give visual and audible alarm and send notification to the AsteraApp if they are being moved during an event.



DJ Feature

Auto BPM analyzes the beat and matches programs to it, flash buttons can trigger special effects while being held down.



Other features

The AsteraApp is packed with many additional items and new features are frequently added via software update.

TUBES. FOR EVENTS. FOR FILM. FOR BOTH.



Max. 20h



App



Wireless DMX



IP65

HELIOS TUBE

TITAN TUBE

HYPERION TUBE

Designed for Film/Broadcasting lighting and the highest performance. All 3 tubes are optimized for ultra-high CRI/TLCI and peak brightness. In addition to wireless power and control they can be wired with power and data through a single cable.

PIXEL TUBE

An affordable yet very powerful battery LED tube for stage and event and entertainment lighting. It can be used as on stages and around event sites and can be used to create stunning lighting effects. A highly creative device that offers an infinite range of possibilities.

EXCLUSIVE FEATURES OF HELIOS, TITAN & HYPERION TUBE

Backside Display
Quick access to DMX setup, colors and hue, saturation, intensity control and more

Wired Power/Data Connection
via power/data combination cable



Boost Mode
Ultra-bright when displaying white color for almost 2h or while connected to AC



Ultra-High Color Rendering
TLCI ≥ 96, CRI Ra ≥ 96, CRI Re ≥ 90 from 3.200K to 6.500K



Tunable white
with range from 1.750K to 20.000K

SPECIFICATIONS

Pixel	8	16	32	16
Max Power Draw	24 W	48 W	96 W	16 W
LED Power	36 W	72 W	144 W	28 W
Brightness in white*	1.340 lm	2.900 lm	5.800 lm	955 lm
Tube Type	HELIOS TUBE	TITAN TUBE	HYPERION TUBE	PIXEL TUBE

Item Code	FP1	FP2	FP3	AX1
Size	Ø42 x 550 mm Ø1.6 x 21.65 inch	Ø42 x 1.035 mm Ø1.6 x 40.7 inch	Ø42 x 2.031 mm Ø1.6 x 66.43 inch	Ø42 x 1.035 mm Ø1.6 x 40.7 inch
Max Power Draw	24 W	48 W	96 W	16 W
Emittance*	393lx @1 m	785lx @1 m	1.570lx @1 m	270lx @1 m
Illuminants	RED, GREEN, BLUE, MINT, AMBER			RGBW
CRI (Ra) 3200-6500k*	≥96			≥80
TLCI 3200-6500k*	≥96			n/a
IP-Rating	IP65			
DMX	Wireless + Wired			Wireless
Strobe	0-25 Hz			
Battery Lifetime	70 % after 300 cycles			
Battery Runtime	up to 20 hours			
Charging Time (nominal)	3 hours			5 hours
Input Voltage	24V DC, 1A	24V DC, 2A	24V DC, 4A	48V DC, 0.5A
Wireless Frequencies	CRMX 2.4GHz, UHF			
Range	300m; 330 yds			
Wired DMX	yes	yes	yes	no
CRMX Receiver	Built-in			
Housing	Polycarbonate; metal end caps			
Operating Temperature	0°-40° C; 32°-104° F			
Weight	0,765 kg; 1.69 lbs	1,35 kg; 3.0 lbs	2,9 kg; 6.39 lbs	1,1 kg; 2.5 lbs

*typical values

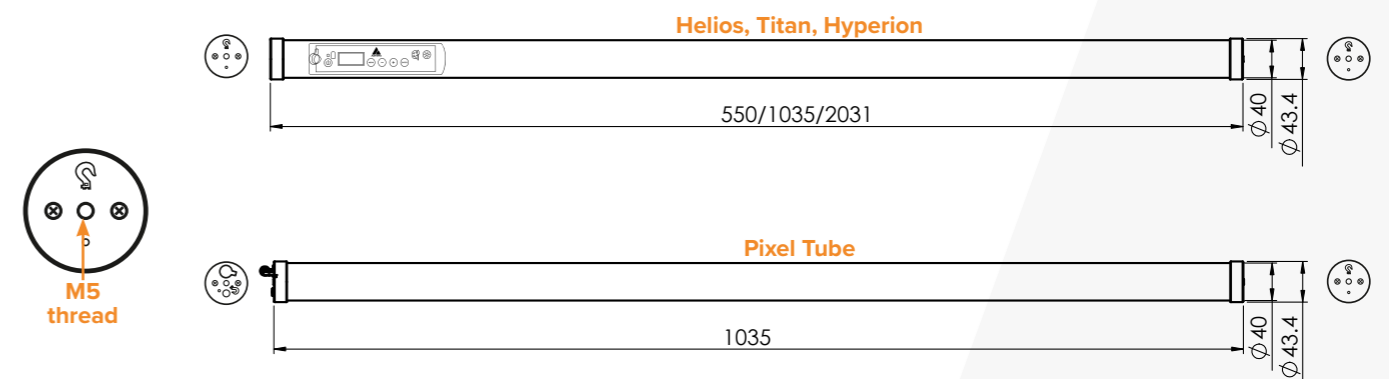

UNLIMITED POSSIBILITIES

WITH ORIGINAL ACCESSORIES FOR TUBES FROM ASTERA



Crossplate
Connects up to 4 tubes to one Babypin (welded to backside)
AX1-CP



Wingplate
Hang tubes via one babypin or connect several tubes together
AX1-WP



Babypin
Connects Holder/Wingplate to Manfrotto and Matthews clamps
AX1-BLT



Holder
Fix tubes via screws or babypin to walls and structures
AX1-H

Get creative with Crossplate, Wingplate, Babypin & Holder

Mount up to 4 Tubes with the Crossplate



Wingplate + 2 Holders + Babypin for easy single mount on different constructions



Create shapes with Wingplates + Holders

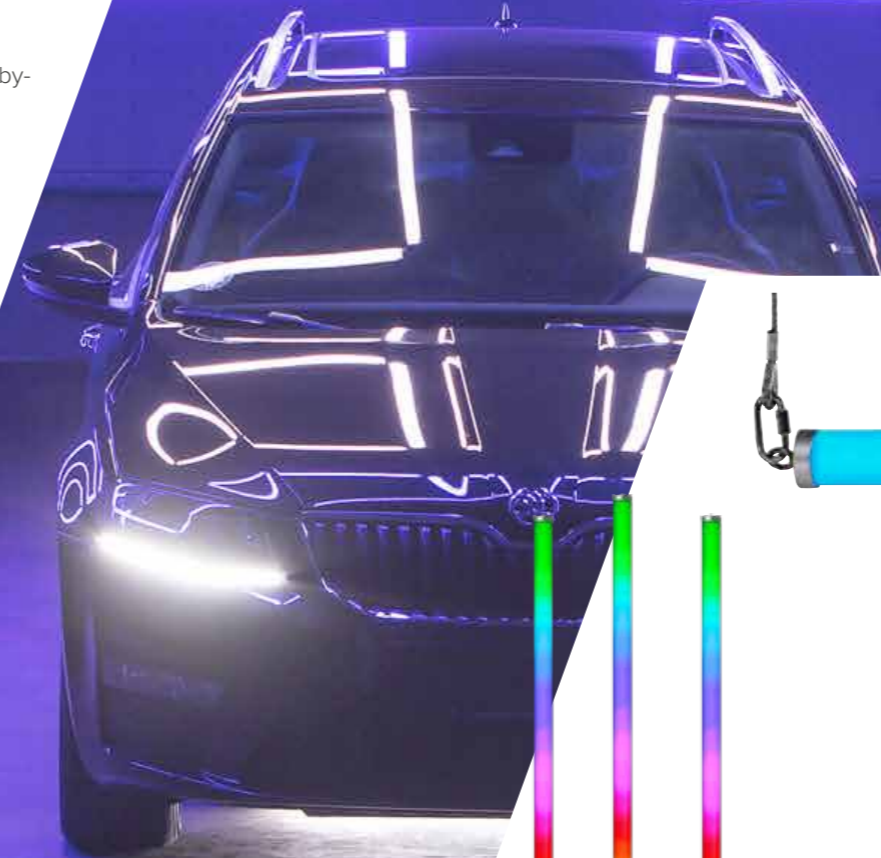

©Kaiser Showtechnik - www.kaiser-sales.de



Eyebolt + Cable for safe hanging if Tube mounted on truss or pipe



Eyebolt + Cable + Holder + splint for safe hanging (not for AX1)



Helios Handle

Use Helios as a handheld light (only suitable for Helios Tube)
FP2-HND

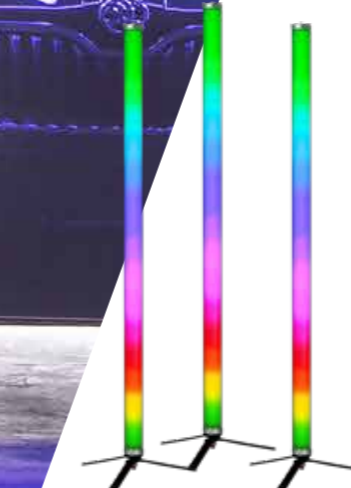

Stand

Foldable tripod for a quick setup
AX1-STD



Eyebolt

Eyebolt for hanging Titan, Helios and Hyperion Tubes (also as secondary mounting for all Tubes)
AX1-EBLT

TUBE-SETS & CASES

Cases for charging and safe transportation of your tubes and accessories.

HELIOS TUBE SET

765 x 503 x 260 mm
29 kg/64 lbs (full weight)
FP2-SET

8x Helios Tube

- 16x Babypin
- 16x Holder
- 1x PowerBox
- 1x AC Cable
- 16x Eyebolt
- 8x Stand

Removable PowerBox for flexible power supply and data connection

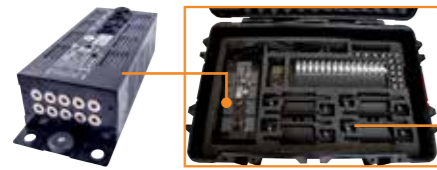

Dedicated spaces for all included accessories and wingplates



Softbags for Titan, Helios and Pixel Tube

SOFTBAG TITAN/PIXEL TUBE

For up to 4 Titan Tubes / Pixel Tubes and all their accessories, power supplies, wingplates, cables and more
1085 x 310 x 175 mm
FP1-SB



SOFTBAG HELIOS TUBE

For up to 4 Helios Tubes and all their accessories, power supplies, wingplates, cables and more
590 x 300 x 132 mm
FP2-SB



TITAN TUBE SET

1147 x 443 x 157 mm
35 kg/77 lbs (full weight)
FP1-SET

8x Titan Tube

- 16x Babypin
- 16x Holder
- 1x PowerBox
- 1x AC Cable
- 16x Eyebolt
- 8x Stand

Removable PowerBox for flexible power supply and data connection

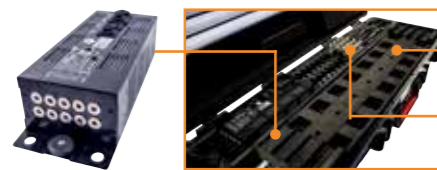

Inlay for a safe transport and space for up to 8 Wingplates



Dedicated spaces for all included accessories and wingplates



PIXEL TUBE SET

1147 x 443 x 157 mm
33 kg/73lbs (full weight)
AX1-SET

8x Pixel Tube

- 16x Babypin
- 16x Holder
- 1x AX1 ChargingBox
- 16x Eyebolt
- 8x Stand

Removable ChargingBox for flexible power supply



Inlay for a safe transport and space for up to 8 Wingplates

Dedicated spaces for all included accessories and wingplates



HYPERION TUBE SET

2262 x 394 x 149 mm
29 kg/64 lbs (full weight)
FP3-SET

4x Hyperion Tube

- 8x Babypin
- 8x Eyebolt
- 8x Holder
- 4x Wingplate
- 1x Power Supply Unit Adapter
- 4x Power Supply Unit
- 1x DataLink

Removable DataLink for flexible power supply and data connection



Dedicated spaces for all included accessories



All Tube Cases come with:

ROLLERS
not Hyperion Set



HANDLE



IN CASE CHARGING



RUGGED CASE



CHARGING & CONNECTING

FP1-PWB **POWERBOX**

Charges your Titan & Helios Tubes inside the case or powers them during usage. Also enables wired DMX connection.

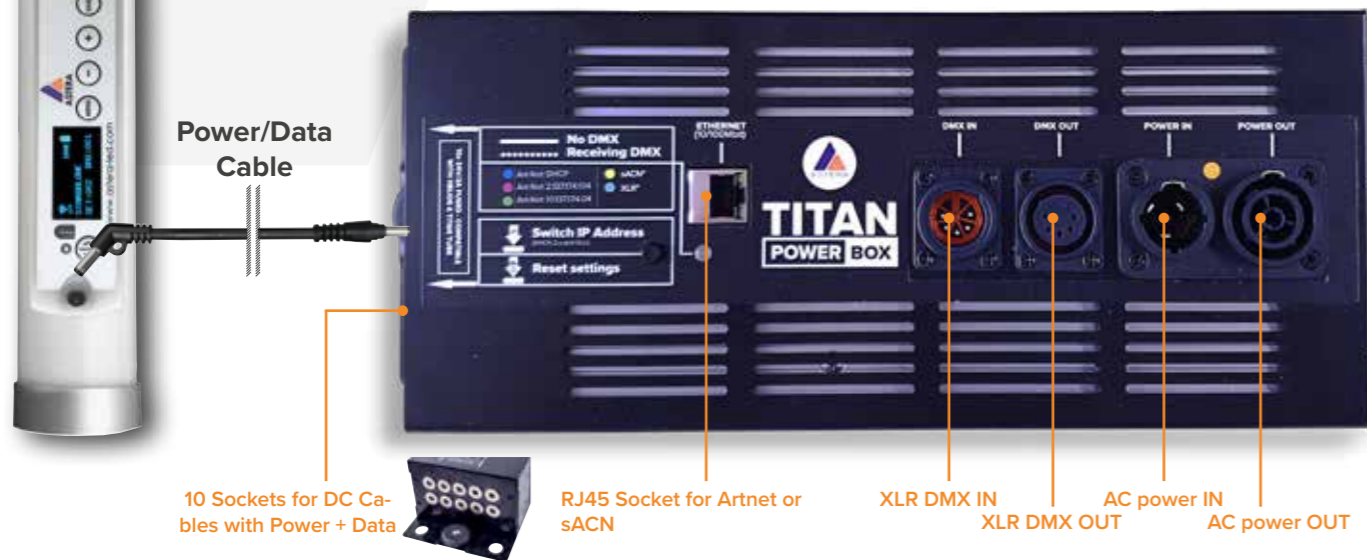

Power Supply



AX1 Pixel Tube Power Supply
AX1-CHR

48V, 0,5A output



Helios/Titan Tube Power Supply
FP1-CHR

24V, 2A output



Hyperion Tube Power Supply
FP3-CHR

24V, 4A output

Cables



AX1 Extension Cable
AX1-EXC

Extend the PSU cable length by 5m



Helios, Titan, Hyperion Tube Extension Cable
FP1-EXC

Extend the PSU cable length by 5m



Power/Data Cable
FP1-PWB-CAB-5/10/15

Transfer Power + Data through a single cable; 5, 10 or 15m length

DATALINK FP3-DTL

Add DMX data to your tube. Designed for use with individual chargers. Especially for Hyperion Tube.

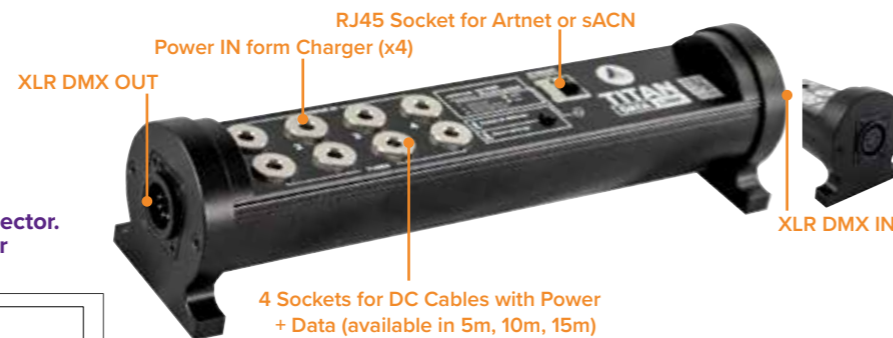

Power/Data connection with PSU. DMX connector. Up to 4 tubes can be connected with 4 power supplies

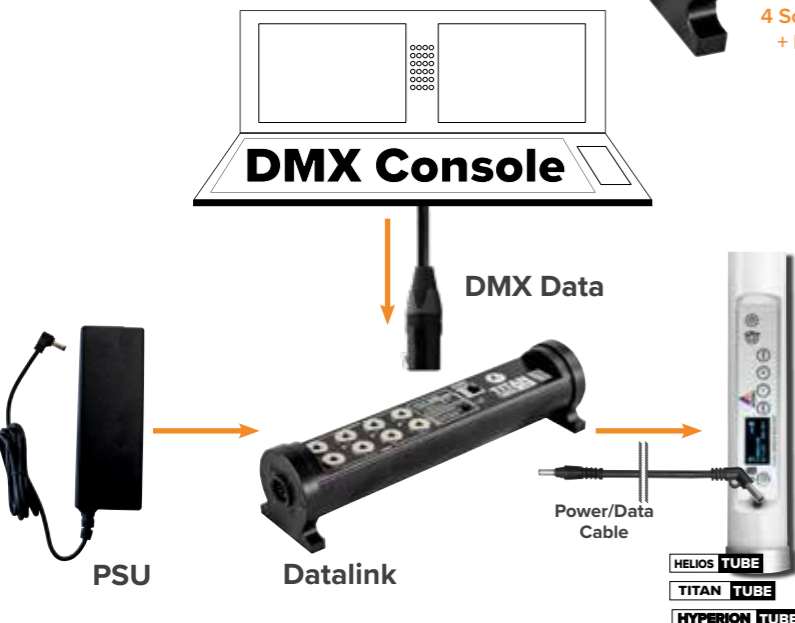

Connecting multiple DMX universes to 1 Powerbox

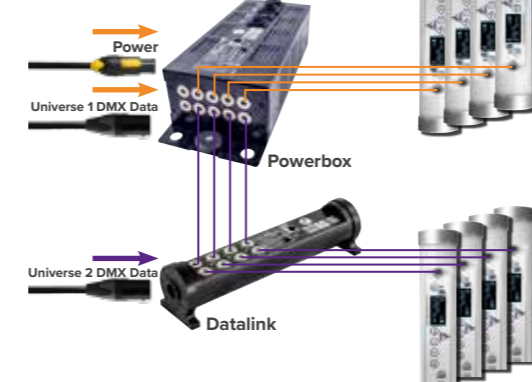

Typical spectra of Titan Tube

3200K

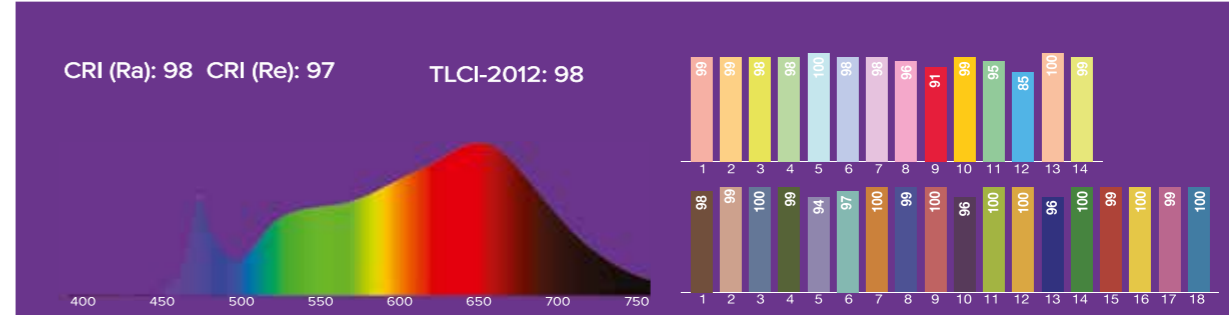

4000K

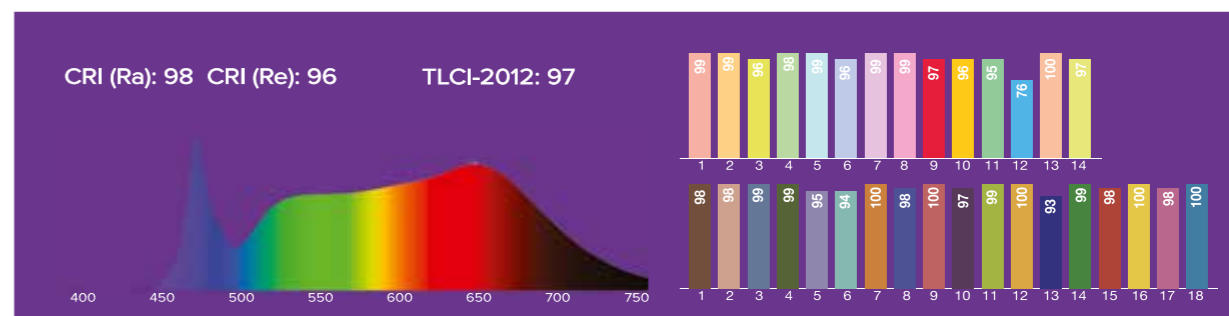

5500K

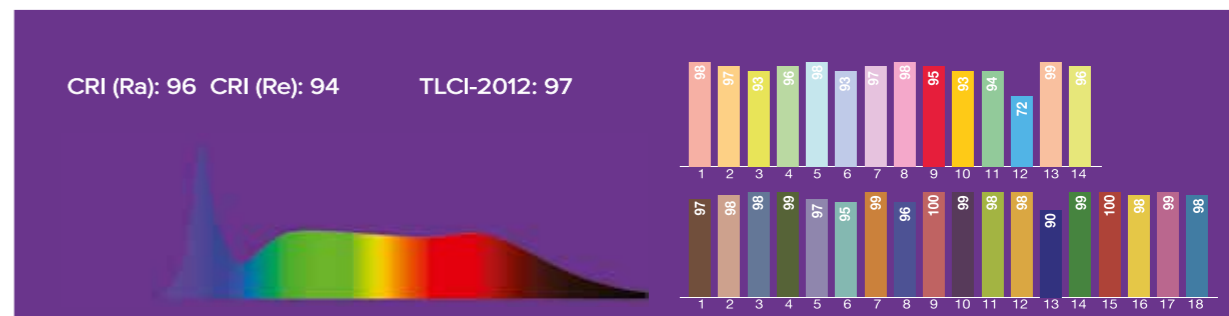

AX5 TriplePAR

3-in-1 The Perfect PAR

Optimized for a fast return on investment, AX5 replaces your wireless and wired PARs as well as battery uplights.



Max. 20h



App



Wireless DMX



IP65

45W RGBAW

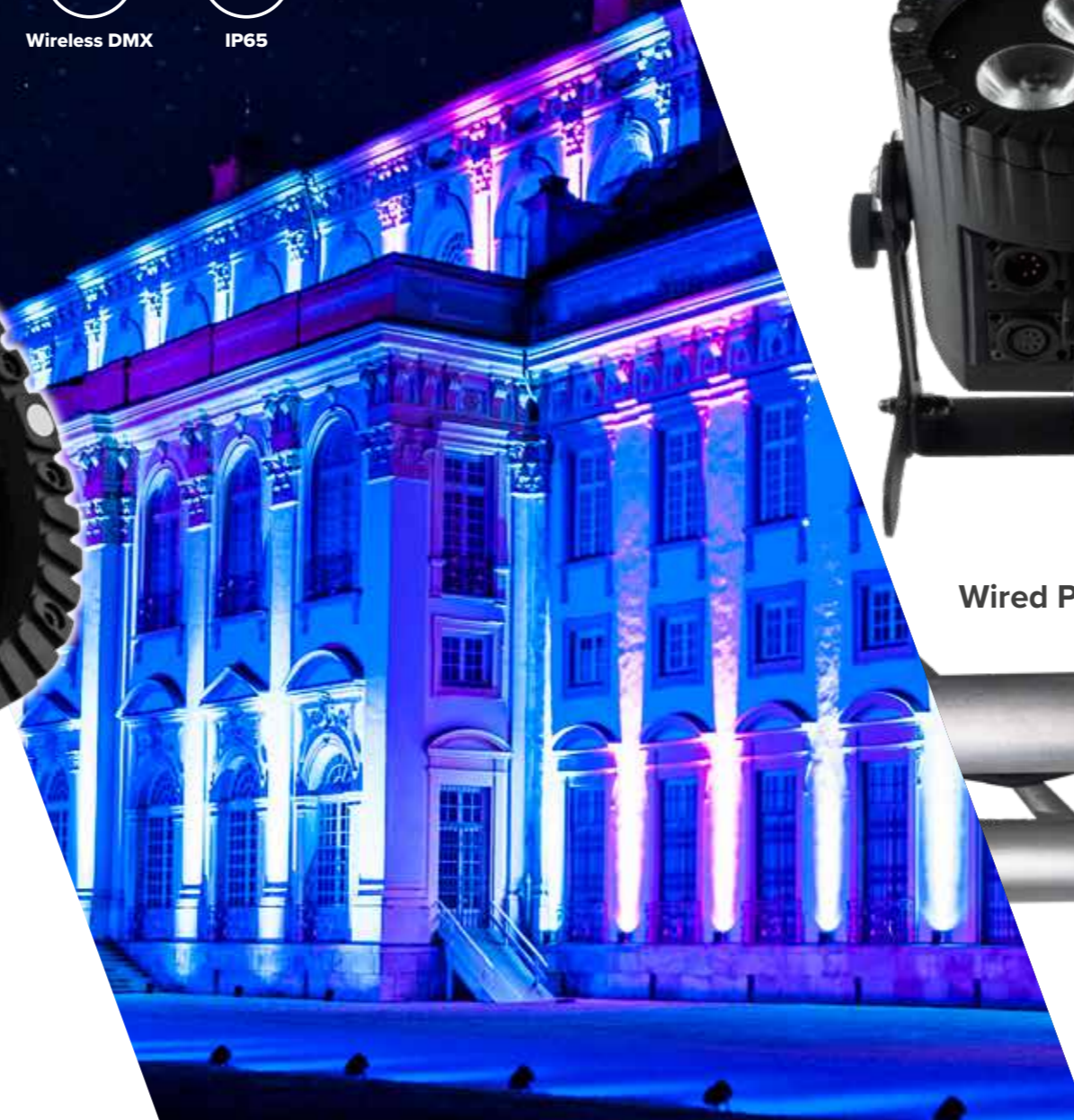

3-IN-1

Wireless PAR



Elegant Uplight



Adjustable Kickstand for flexible wall uplighting

Wired PAR



Babypin AX1-BLT

Waterproof Connectors
Powercon True1 & XLR, IP65 while plugged or unplugged



Stand

Foldable and with thread for hanging



Removable Bracket

Turn your AX5 into an uplight in seconds



3x15 RGBAW LED

And high CRI due to individual factory calibration

MECHANICAL FEATURES



COVERS Transform your AX5

Different shapes and colors available.



Flex Cover White
AX5-FLXCVR-WT



Flex Cover Mirror
AX5-FLXCVR-MIR



Volcano Cover White
AX5-VULCVR-WT

SPECIFICATIONS

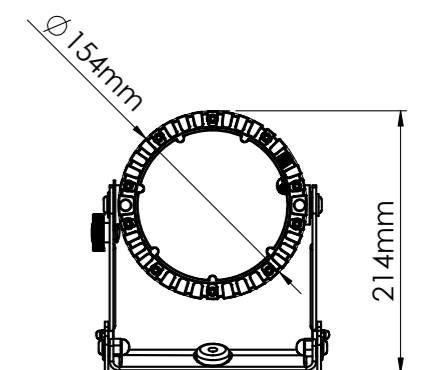
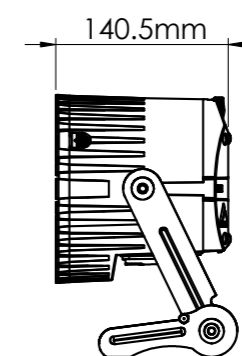

Item Code	AX5
Colors	RGBAW
Total LED Power	45W
Luminous Flux*	1,340lm
Emittance*	4,800lx (@2m; white 3200K)
CRI*	92 (@2700~4000K)
Strobe	0 - 25Hz
Beam Angle	13°
Pixels	1
Battery Lifetime	70 % after 300 cycles
Battery Runtime	up to 20 hours
Charging Time (nominal)	5 hrs

Input Voltage	90 - 260V, 50/60 Hz
Range	300 m / 330 yds
Wired DMX	Yes
CRMX Receiver	Built in
Wireless Frequencies	CRMX 2.4GHz, UHF
Housing	Aluminium with plastic ring
IP Rating	IP65
Operating Temperature	0° - 40° C / 32° - 104° F
Dimensions (mm)	145 x 190 x 221
Dimensions (inches)	5.7 x 7.5 x 8.7
Weight (kg/lbs)	3.4 / 7.5

*typical values

FILTERS & DIFFUSERS



Snoot

With built-in honeycomb, narrows your beam and helps to avoid glare.

AX5-SN

Diffuser Dome

Create a stunning light ball or softlight projector with the two included filters.

AX5-DDM

Softlight effect



Eyecandy effect



Clip-in Filters

High-efficiency wallwash, flood & rotatable filters

Rotatable Filter (17°x46°)

AX5-ROTAD



INCLUDED

Wallwash Filter (17°x46°)

AX5-WWF



Flood Filter (32°)

AX5-FF



CHARGING & TRANSPORTING

CHARGING CASE

740 x 580 x 540 mm
45 kg/99 lbs (full weight)

AX5-CHRCSE



DEDICATED SPACE FOR

8x (max) TriplePAR

8x AX5 Bolt



8x Bracket



1x Charging Plate



8x Super Clamp



16x Filter



Exact case design varies from country to country

Removable Charging Plate



Dedicated spaces for Feet

Dedicated spaces for Filters

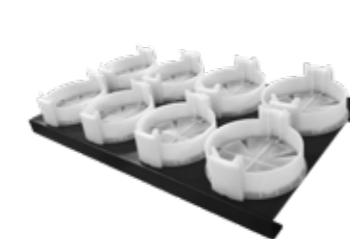

Fits in standard 60x40 cm plastic box

CHARGING PLATE (FOR 8)

700 x 540 x 250 mm
8 kg/17.6 lbs (empty weight)
(only on request)

AX5-CHRPLT-8

CHARGING PLATE (FOR 4)

556 x 356 x 210 mm
4.1 kg/9 lbs (empty weight)

AX5-CHRPLT-4

AX3 LightDrop

The AX3 is a battery operated, easy to use IP65 RGBW puck aimed at stage lighting and corporate events. It can be used as uplight as well as hanging or standing spotlight and inside translucent objects, truss, etc. It is extremely compact and yet offers a high brightness paired with long battery runtime and range.



Max. 20h



App



Wireless DMX



IP65

15W RGBW



Small yet powerful
only 95mm diameter and 59mm height (inches 3.7x2.3)



Removable Bracket

3/8" thread for hanging and mounting on truss

3x M4 thread for hanging and safety

Backside magnet for easy mounting

Adjustable kickstand for flexible wall uplighting



Insert AX3 into AX5 Diffuser Dome

FILTERS & DIFFUSERS



Base for AX5 Diffuser Dome
AX3-DDB



Diffuser Dome
AX3-DDM



Wallwash Filter (17°x46°)
AX3-WWDSK

INCLUDED



Flood Filter (30°)
AX3-DDSK-30

INCLUDED



Diffuser Filter (120°)
AX3-DDSK-120

SET & TRANSPORT

Charge up to 8 AX3

Space for filters, cables and accessories

CHARGING CASE

520 x 400 x 140 mm
12,4 kg/27.3 lbs (full weight)
AX3-CRMX-SET



8 AX3 including Brackets

8 30° Filter

8 120° Filter

32 Rubber Feet

24 Hook

8 Socket Cover

1 Power Cord

SPECIFICATIONS

Item Code	AX3-CRMX
Colors	RGBW
Total LED Power	15W
Luminous Flux*	430lm
Emittance*	1,300lx (@2m; white 6500K)
CRI *	n/a
Strobe	0 - 25Hz
Beam Angle	13°
Battery Lifetime	70% after 300 cycles
Battery Runtime	up to 20 hours
Charging Time (nominal)	5 hrs

Input Voltage	5 V DC / 3A
Range	300 m / 330 yds
Wired DMX	No
CRMX Receiver	Built in
Wireless Frequencies	CRMX 2.4GHz, UHF
Housing	ABS
IP Rating	IP65
Operating Temperature	0° - 40° C / 32° - 104° F
Dimensions (mm) with bracket	120 x 59 x 114
Dimensions (inches) with bracket	4.7 x 2.3 x 4.4
Weight	0.679 kg / 1.4 lbs

AX10 SpotMax

AX10 is the brightest and the most advanced battery operated entertainment spotlight; it features high quality Philips RGBAW LEDs, TruColour calibration, long-life LG-Chem batteries and a uniquely engineered housing to increase cooling and optimize performance. Battery powered, remote controlled, IP65 and a carry handle built into its stand.



Max. 20h



App



Wireless DMX



IP65

135W RGBAW



Attached to truss with Super Bolt/Clamp attached



Foldable Legs for easy carrying



9x15 RGBAW LED

And high CRI due to individual factory calibration

ACCESSORIES



Rotatable Filter (17°x46°)
AX10-ROTAD

INCLUDED



Flood Filter (32°)
AX10-DDSK

INCLUDED



Wallwash Filter (17°x46°)
AX10-WWDSK



Charging Case
AX10-CHRCSE
(on request)



Super Bolt for hanging
AX10-BLT

SPECIFICATIONS

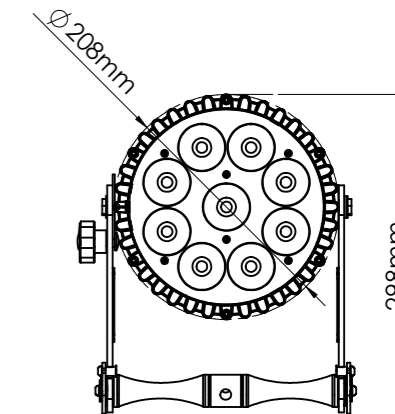
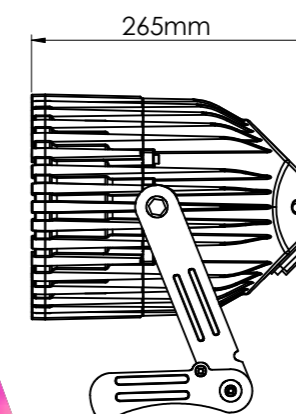

Item Code	AX10-U	Input Voltage	110 - 240V, 50/60 Hz
Colors	RGBAW	Range	300 m / 330 yds
Total LED Power	135W	Wired DMX	No
Luminous Flux*	3,350lm	CRMX Receiver	Built in
Emittance*	10,350lx (@2m; white 4000K)	Wireless Frequencies	CRMX 2.4GHz, UHF
CRI*	≥92	Housing	Aluminium
Strobe	0 - 25Hz	IP Rating	IP65
Beam Angle	13°	Operating Temperature	0° - 40° C / 32° - 104° F
Pixels	1	Dimensions (mm)	279 x 296 x 253
Battery Lifetime	70 % after 300 cycles	Dimensions (inches)	10.9 x 11.6 x 9.9
Battery Runtime	up to 20 hours	Weight	7.98 kg / 17.5 lbs
Charging Time (nominal)	5 hrs		

AX2 PIXEL BAR Coming soon

Astera's Wireless PixelBar is a linear wash fixture. Each of its LEDs can be individually addressed and offers ultra-high color rendering, digital color calibration and a native 20° beam. Thanks to its smart stands, hanging bracket, connectable endcaps and the integrated airline track it can be quickly assembled in numerous ways and is suitable for a wide variety of applications such as concert/touring, corporate events, TV etc.

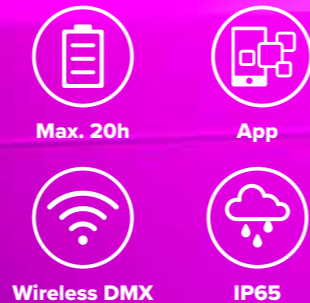

Available in 2 sizes
50cm with 8x10W and 100cm with 16x 10W (20" and 40")



Removable feet
Multi-functional feet with quick-release clamp



Connector
for connecting several AX2.
With IR-Module for easy communication



Ultra-High Color Rendering
TLCI ≥ 96, CRI Ra ≥ 96, CRI Re ≥ 90 from 3.200K to 6.500K



Individually Controllable Pixels
8 pixels for AX2-50
16 pixels for AX2-100



Barndoors
Control the shape of the light

ACCESSORIES



TrackPin
AX-TP



TrackHanger
AX-TH



FlyBar
AX2-FB

Mounting on truss, pipes and more with TrackPin

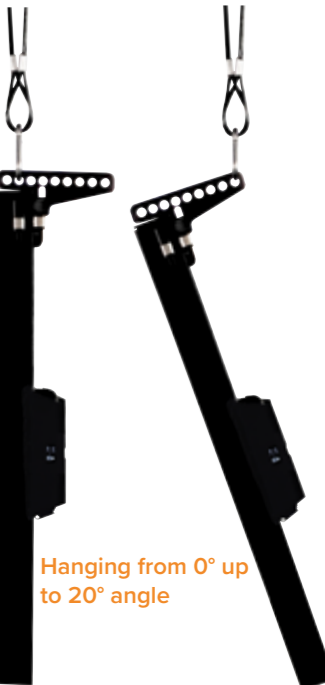



Hanging from 0° up to 20° angle

Airline Track
Airline track at back and bottom to attach mounting tools

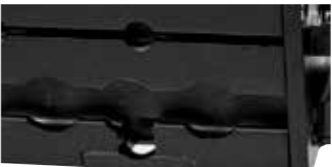

Safety Hook
Helps to hang AX2 safe - please check the safety regulations in your region.

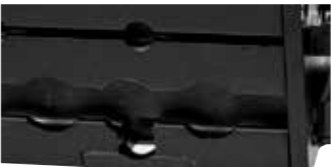

SPECIFICATIONS

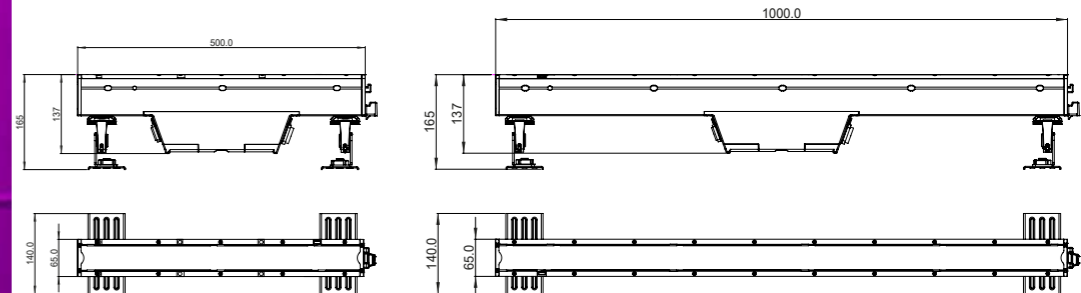

Item Code	AX2-100 / AX2-50
Colors	RGBMintAmber
Total LED Power	160W / 80W
Power Draw	80W / 40W
Light output - 2700k, 3200k,5500k (100)*	3600lm, 4460lm, 4530lm
Light output - 2700k, 3200k,5500k (50)*	1800lm, 2230lm, 2265lm
CRI(RA)/TLCI 3200-6500k*	≥96
Strobe	0 - 25Hz
Pixels	16 (8)
Battery Lifetime	70 % after 300 cycles
Battery Runtime	up to 20 hours
Charging Time (nominal)	5 hrs

Input Voltage	110 - 240V, 50/60 Hz
Range	300 m / 330 yds
Wired DMX	Yes
CRM Receiver	Built in
Wireless Frequencies	CRMX 2.4GHz, UHF
Housing	Aluminium
IP Rating	IP65
Operating Temperature	0° - 40° C / 32° - 104° F
Weight	7.9 kg/17.5 lbs / 4.9 kg/10.8 lbs
Dimensions (mm)	1000 x 165 x 65 / 500 x 165 x 65
Dimensions (inches)	39.4 x 6.5 x 2.6 / 19.7 x 6.5 x 2.6

NYX BULB

The color-tunable LED bulb for professional film, stage and event productions. Not bigger than a normal LED bulb, it contains a CRMX receiver as well as RF and Bluetooth modules for the AsteraApp. It can be powered via E26/E27 thread or with a standard power bank and thanks to its Titan LED engine it displays precise colors and white tones with ultra-high CRI and TLCI.



App



Wireless DMX

INCLUDED



USB DC Cable
FP5-USBC



TrackPin
AX-TP



PowerStation Hanger
FP5-PSH



CupBouncer
FP5-CPB

ACCESSORIES



Tunable white
with range from 1,750K to 20,000K



Ultra-High Color Rendering
TLCI ≥ 96, CRI Ra ≥ 96, CRI Re ≥ 90
from 3,200K to 6,500K



Dual Power Input

Power through E27/E26 AC thread or external (standard power bank or NYX PowerStation)



Precise Colors

Display exact CCT, RGB & HSI values or reproduce standard color gels

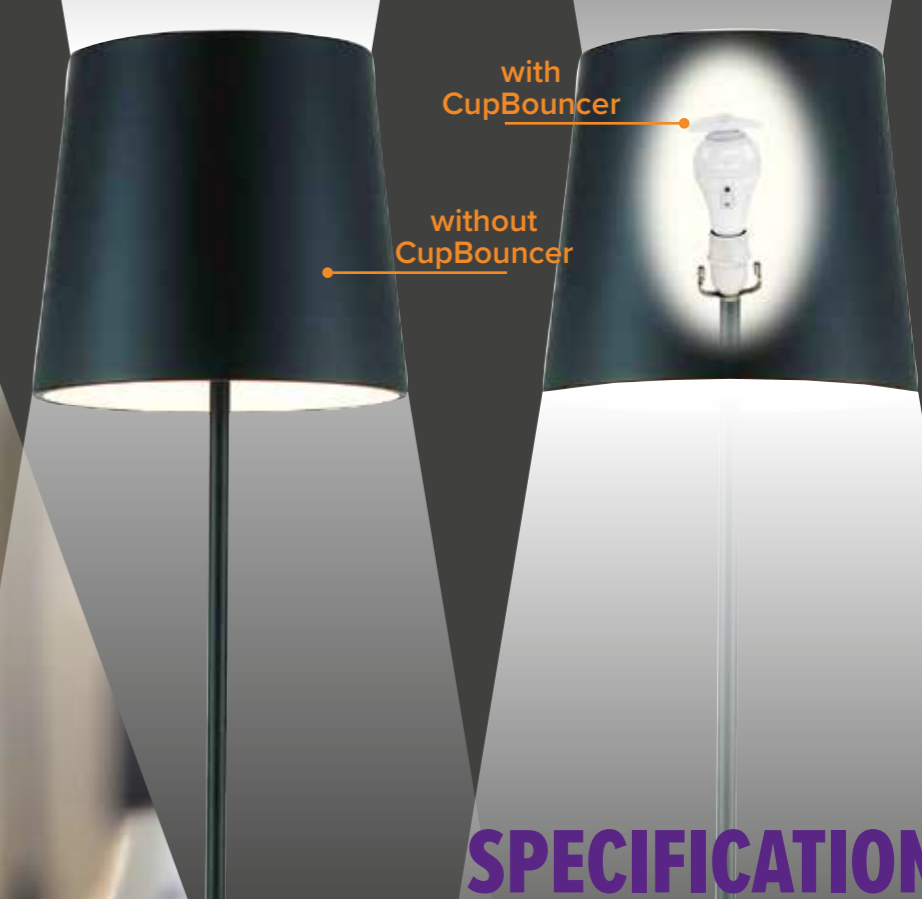

with CupBouncer

without CupBouncer

SPECIFICATIONS

Item Code	FP5-E27 (EU, Asia, AUS) / FP5-E26 (America, JP, TW)	AC Power input E26	100-120V 50/60 Hz via E26 thread
Colors	RGBMintAmber	DC Power input	5-18V at 2A
Total LED Power / Power Draw	14W / 10W	Wired DMX	No
Luminous Flux*	750lm (@4000k)	CRMX Receiver	Built in
CRI(RA)/TLCI 3200-6500k*	≥96	Wireless Frequencies	CRMX 2.4GHz, UHF, Bluetooth LE 5.0
Strobe	0 - 25 Hz	Dimensions (mm)	Ø70 x 130
Battery	only external	Dimensions (inches)	Ø2.76 x 5.12
AC Power input E27	100-240V 50/60 Hz via E27 thread	Environment	Outdoor (IP44 when connected with AC + Rubberplug)

PowerStation for NYX Bulb

Connect the integrated cable to your bulb's DC connector to power it up. While connected, the PowerStation acts as a remote display to program DMX addresses and settings which the bulb will store in its memory. It can also set colors, effects, brightness etc which the bulb will continue to display when in a powered lamp socket or connected to a power bank. Apart from its backside magnets the PowerStation features an airline track to attach mounting accessories such as TrackPin and PowerStationHanger.

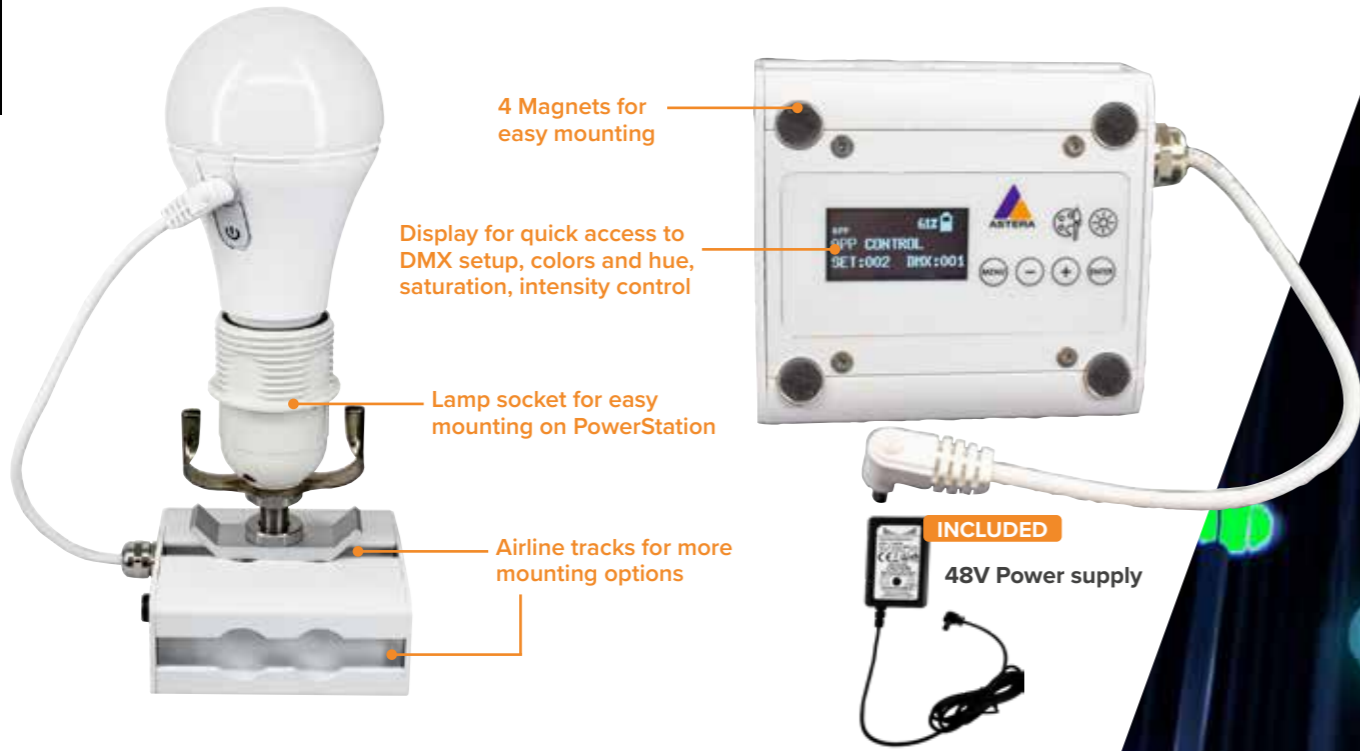

SPECIFICATIONS

Item Code	FP5-PS
Power IN	24-48V
Power OUT	15V 0.7A
Battery	3350mAh
Charging time (nominal)	5h
Dimensions (mm / inch)	96 x 80.8 x 42.4 / 3.8 x 3.2 x 1.7
Weight (kg/lbs)	0.4 / 0.89

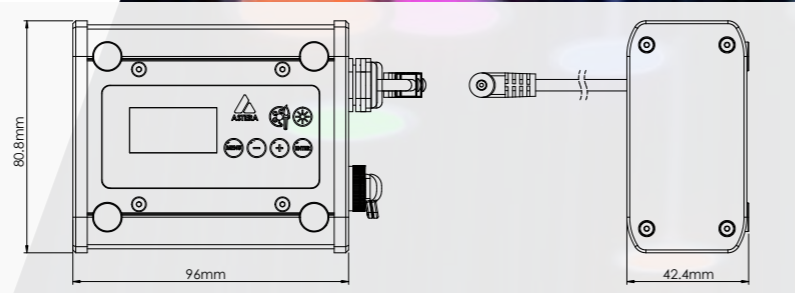

Sets

NYX BULB SET
 414 x 334 x 130 mm
 16.3 x 13.1 x 5.1 inches
 5.3 kg/11.7 lbs (full weight)
 FP5-SET



- 8x NYX Bulb**
- 1x PSU
 - 1x Power Station
 - 8x USB Cable
 - 8x Cup-Bouncer

POWERSTATION SET
 520 x 400 x 140 mm
 20.5 x 15.7 x 5.5 inches
 8,5 kg/18.7 lbs (full weight)
 FP5-PS-SET



- 8x PowerStation**
- 1x PSU
 - 8x PowerStation Hanger
 - 8x TrackPin
 - 8x Lamp socket
 - 1x DC SplitCable
 - 8x Bridgecable

Connect the 8 PowerStations with the 8 NYX Bulbs for easy programming.

Charge PowerStations directly in the case.

NYX Bulb as Transmitter

COMING SOON VIA SOFTWARE-UPDATE

Connect directly to a NYX Bulb via Bluetooth. This Master light will revert AsteraApp commands to all other NYX Bulbs and other Astera lights via UHF band.

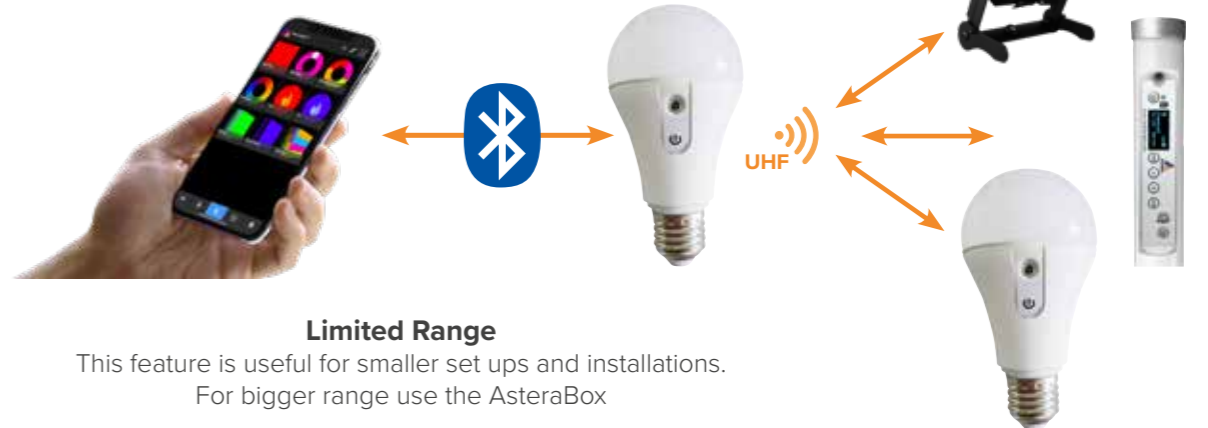

Limited Range

This feature is useful for smaller set ups and installations. For bigger range use the AsteraBox

ASTERA APP

The most powerful lighting control App for film and event lighting

The AsteraApp is the result of 10 years of development and specifically designed for fast and efficient temporary light setups.

It is much more than a lighting control app as it also does all the setup that would usually be done on the light itself and enables many new features that cannot be found in any other light. All in all, it is a huge time-saver when setting up, monitoring or controlling lights.



COLOR

The AsteraApp offers several ways to select colors such as color-wheel, Filter Gels, color temperature, HSI, RGB and CIE 1931. Thanks to Astera's ultra-precise Truecolor calibration Astera fixtures can display the precise color that was selected.



PROGRAMS

Create complex programs out of colors, effects and settings. Save them as tiles and launch them at a fingertip. The lights will remember and repeat these effects without requiring a constant wireless link.

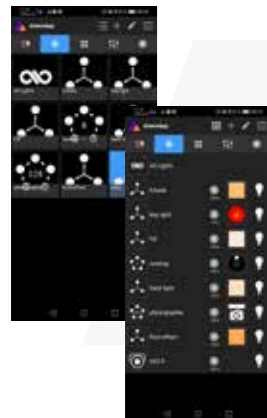

TARGETS

Quickly create groups of lights, assign positions and select which lights should receive commands. In Q4 2019 we launched an alternative view which is optimized for the workflow of cinematographers.

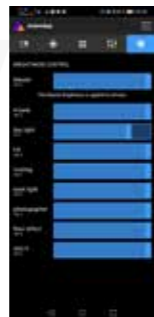

BRIGHTNESS

Set exact brightness levels of individual lights, groups or all lights. Switch them temporarily into an energy-saving standby mode when you don't want to drain the battery.



SETTINGS

Change your light's DMX addresses, footprints, etc... without touching the lights. Select multiple lights and change their settings together to save even more time.



TALKBACK+

Bi-directional communication is deeply integrated into AsteraApp and Astera lights. Get a list of all your lights and their statuses, even when controlling them by DMX or CRMX. And keep a permanent overview by filtering and sorting by different criteria.

©Knomad Colab - www.knomadcolab.com - #KnomadColab

MORE APP FEATURES



Anti-theft

The light gives visual and audible alarm and send notification to the AsteraApp if they are being moved during an event.



Scheduled Stand-by

Switch lights into power-saving standby and schedule them to wake up when the production starts.

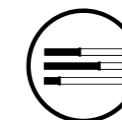

Green/Magenta Correction

Adjust green/magenta during content creation to reduce post-production work.



Flicker Free

Scrambled PWM technology to avoid flickering when filming.



Effects

Quickly build programs out of colors and effects, trigger them or make them match a beat.



Dynamic Power-boost

This exclusive feature makes the light able to display the maximum brightness at all time and intensify non-white colors.



Emergency Lights

Switches to white light when AC power is cut out to keep your event safe.



DJ Feature

Auto-BPM analyzes the beat and matches programs to it, flash buttons can trigger special effects while held down.



Seamless Runtime

Set the length of your production and be sure that your lights won't run out while still getting the maximum brightness.



Other features

The AsteraApp is packed with many additional items and new features are frequently added via software update.

The AsteraApp is packed with many additional items and new features are frequently added via software update.



LAYER EFFECTS

Full control over your pixels

It is now easier than ever to control pixels of your Astera lights and create complex effects. See what you have sent to them and change effect and brightness on the fly.

Up to 8 Layers



11 helpful preset effects

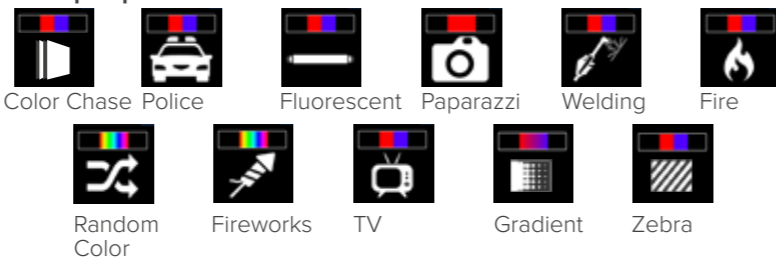

How Layer Effects works



Visually build a bar of pixels that will be displayed live on your tube.

Move the bar with your finger, the tube will respond.

Start motion, the bar will move along the tube and return from the other side.

Virtually lengthen your tube by adding post delay for a perfect process effect.

For more information just watch our webinar „Layer Effects“ at www.astera-led.com/academy



SCENES

Save combinations of programs and targets

Save your current picture on a tile or create tiles that only change defined targets at a time.

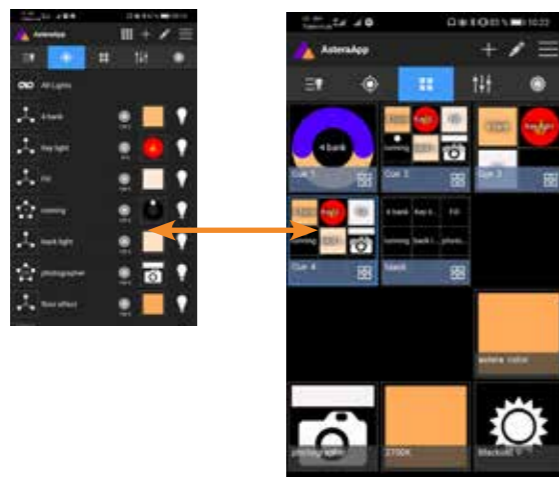

The new Scenes feature allows you to Pre-define sets with a specific effect and save multiple sets in the scene, you are basically making CUE's. It is now faster than ever to change effects to multiple sets at one time.

For more information just watch our webinar „Scenes“ at www.astera-led.com/academy

RF CHARACTERISTICS ASTERABOX

Wireless Modules	EU: UHF (863-870MHz)	USA: UHF (917-922.20MHz)	AUS: UHF (922.30-927.50MHz)	SGP: UHF (920.50-924.50MHz)	KOR: UHF (917.9-921.5MHz)	RUS: UHF (868.75-869.12MHz)	JPN: UHF (922.80-926.40MHz)	CRMX (2402-2480MHz)	Bluetooth 4.1 (2402-2480MHz)
Modulation	FHSS	FHSS	FHSS	FHSS	FHSS	FHSS	FHSS	FHSS	FHSS
ERP (Transmitter)	<25mW	<25mW	<25mW	<25mW	<25mW	<25mW	<25mW	<100mW	2mW (classic) 2mW (BLE)
Channel Count	47	53	53	41	10	6	19	79	79 40

ART7 ASTERABOX

AsteraBox is the interface between lights and controller. It can be used as a wireless DMX transceiver with CRMX technology and also works as interface between the AsteraApp and lights. Its built-in battery enables an easy and time-saving setup, just like with all of Astera's products.



INCLUDED



Carry Case
ART7-CSE

INCLUDED



DMX Adapter
ART7-DMXA

INCLUDED



Power Supply

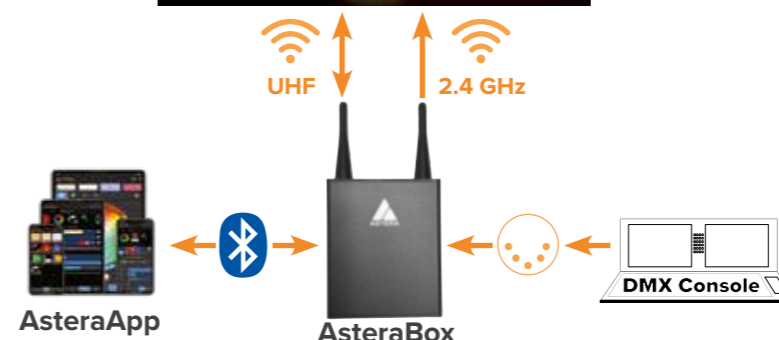
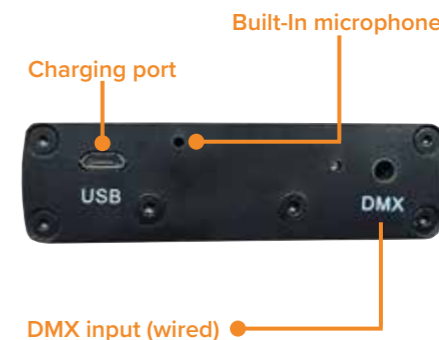
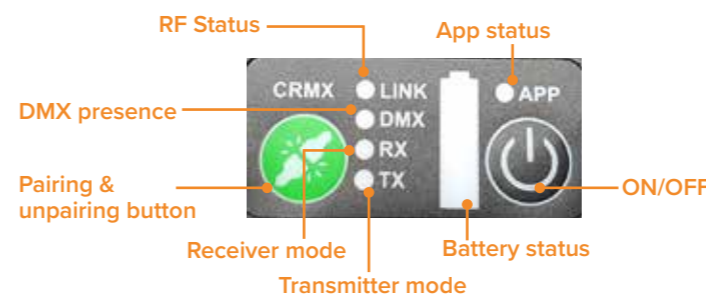

SPECIFICATIONS

Item Code	ART7-U
Battery	Rechargeable Li-Ion
Battery Runtime	72h (App); 18h (CRMX)
Range	CRMX/UHF: 300 m; Bluetooth: 10 m
Frequency	UHF, 2.4GHz
Dimensions (mm/inches)	144 x 78 x 30 / 5.7 x 3.1 x 1.2
Weight (kg/lbs)	0.230 / 0.5



Contact

Aster LED Technology GmbH
Stahlgruberring 36
81829 Munich
Germany

E-mail: info@astera-led.com

Website: www.astera-led.com