



versaSplit

User Guide



Please read these instructions before using the product.

This product has been designed & manufactured for professional use only. It should only be installed by a suitably qualified technician and in accordance with electrical regulations in the country of use.

Unless directed in the instructions there are no user serviceable parts inside the outer case of this product.

Always disconnect from the power supply when not in use.

Any specific IP rating, where appropriate, is given in the instructions. Unless otherwise stated this product is designed for indoor use only. If used outdoors it **MUST** be installed in an appropriate IP rated cabinet. Do not allow this product to be exposed to rain or moisture. Do not allow liquid to penetrate the product.

Please recycle all packaging.

Copyright © Artistic Licence Engineering Ltd. All rights reserved.

[Download the versaSplit user guide \(this document\) here:](#)



versaSplit mono, versaSplit iso

versaSplit mono and versaSplit iso share the same physical configuration, with one input module slot and 10 output connectors. The difference is that the outputs are isolated on versaSplit iso.

Connections

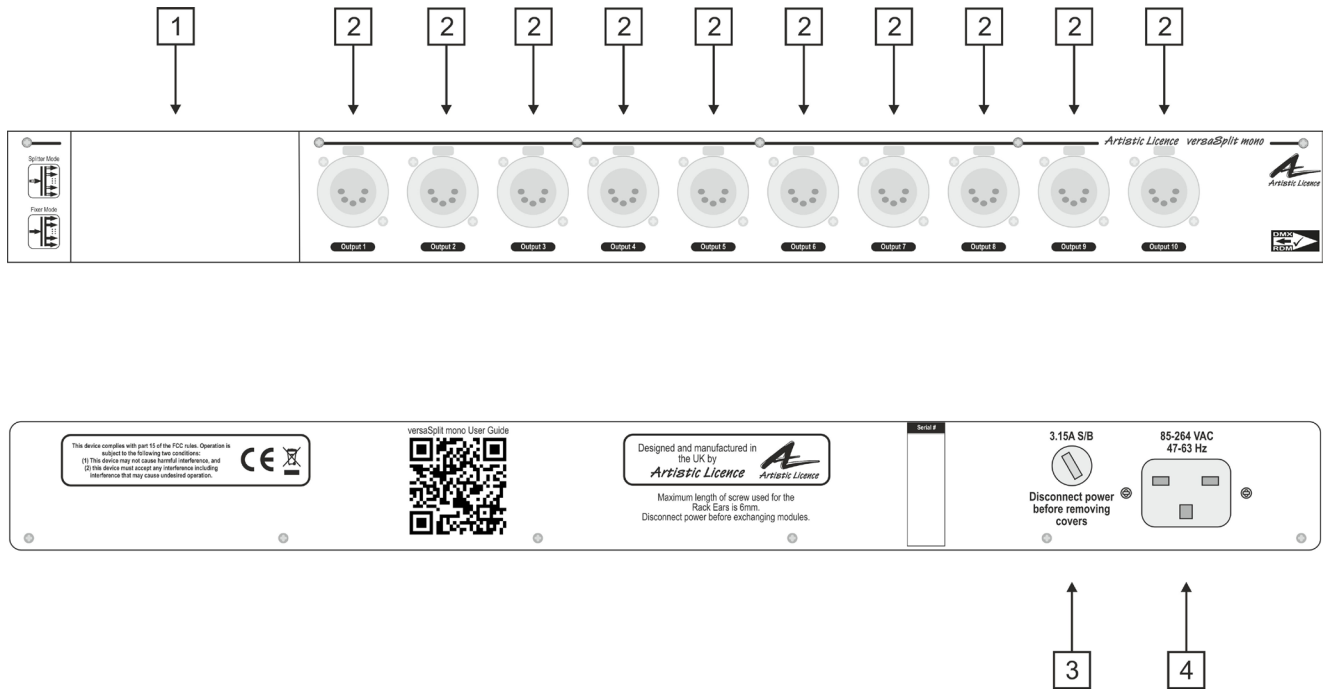

| Ref. | Type | Description |
|------|------------------|----------------------|
| 1 | Data connection | Input module slot |
| 2 | Data connection | Output connector |
| 3 | Fuse | Mains I/P fuse |
| 4 | Power Connection | Mains I/P connection |

Mounting Diagram

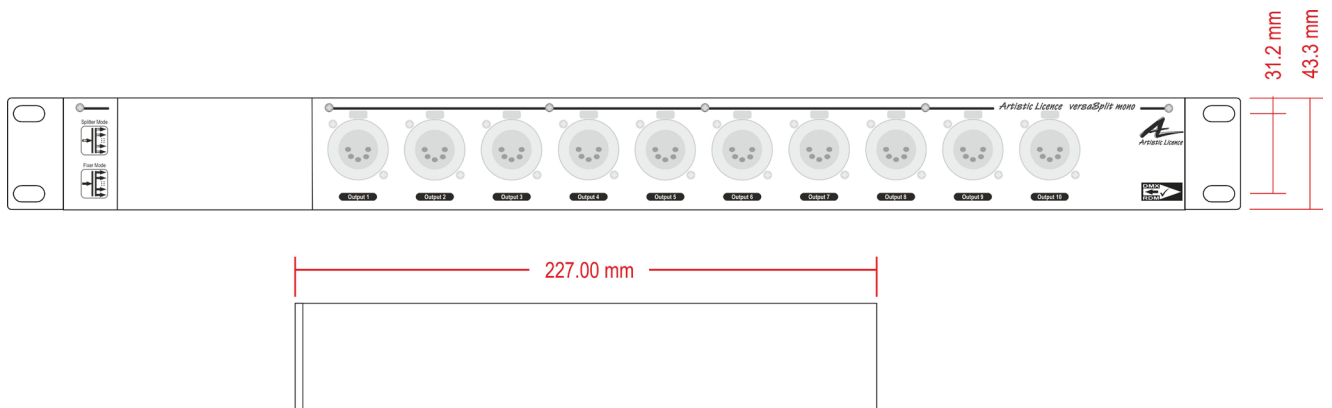

versaSplit duo

versaSplit duo has 2 input module slots and 8 output connectors.

Connections

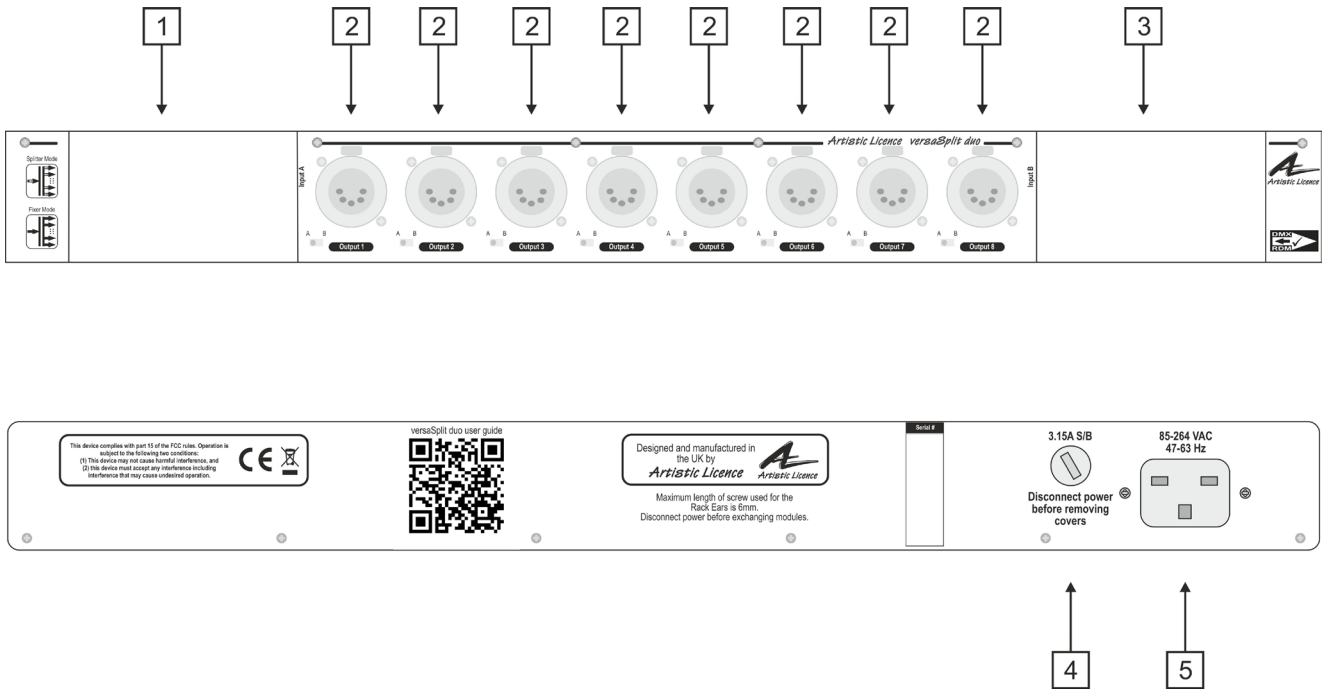

| Ref. | Type | Description |
|------|------------------|----------------------|
| 1 | Data connection | Input module slot A |
| 2 | Data connection | Output connector |
| 3 | Data connection | Input module slot B |
| 4 | Fuse | Mains I/P fuse |
| 5 | Power Connection | Mains I/P connection |

Mounting Diagram

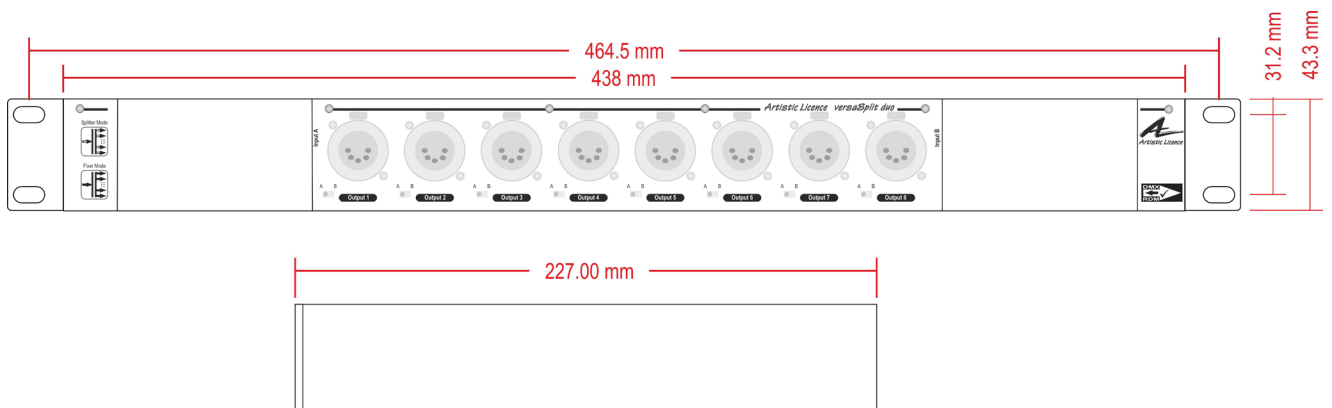

Overview

versaSplit is a modular and configurable rack-mount product that provides a multi-purpose solution for DMX512, ethernet and radio distribution. The product comprises of two main elements:

1. The 'carrier unit': a rack-mount splitter with 10 outputs and one input module slot, or 8 outputs and 2 input module slots.
2. The 'input module': plug-and-play modules that fit into the carrier unit slots. There are 5 different types of input module.

The ability of versaSplit to act as a DMX splitter/fixer, CRMX wireless DMX receiver or ethernet-to-DMX conversion product depends on the choice of input module. The product is supplied with rack ears and a standard IEC mains connector.

Carrier units

- **versaSplit mono**
 - 10 outputs, with a choice of any combination of 5-pin female XLR, 3-pin female XLR and XLR8 (Ethercon RJ45 connectors)
 - 1 input module slot
- **versaSplit iso**
 - As versaSplit mono, but with individually isolated outputs
- **versaSplit duo**
 - 8 outputs, choice of XLR3, XLR5 or XLR8 connectors
 - 2 input module slots, A and B. Each splitter output can be allocated to either the A or B input module using the switch located next to each output
 - Optional 'extreme' model with output surge protection

Input modules

The input modules are key to the design concept underlying versaSplit. There are 5 types of input module that can be swapped in and out of the product as the user desires (this simply requires a screwdriver). The power

must be disconnected before changing the modules.

The input module choices are as follows:

- DMX512/RDM with data fixer, using 5-pin XLR
- DMX512/RDM with data fixer, using 3-pin XLR
- DMX512/RDM with data fixer, using Ethercon RJ45
- Radio with data fixer, using CRMX wireless DMX
- Ethernet module B, compatible with Art-Net, sACN; supports 10/100BaseT

Data fixer

The 'data fixer' for DMX is used to resolve flickering problems that can arise from intra-manufacturer compatibility issues. All of the input modules feature a 'Split/Fix' option to select between this mode ('Fix') and normal ('Split') operation. (On the ethernet module, Fix mode is achieved via disabling RDM in the product's web browser interface, rather than a physical switch on the module).

Standards compliance

The DMX512/RDM input modules support all variants of DMX512, including DMX512-A, and are fully compliant with the Remote Device Management protocol (E1.20 - 2010).

The radio input module is a CRMX wireless DMX receiver based on the CRMXchip from Lumen Radio (<http://www.lumenradio.com/crmxchip>). It does not support RDM.

The ethernet input module uses an Ethercon RJ45 connector and is compatible with all versions of Art-Net and sACN. Cat 5 cable or better is required. Speeds are 10/100BaseT (the module will auto-detect which setting to use).

Power Supply & Earthing

The internal power supply requires an input in the range 90-250 VAC with an Earth connection. The mains fuse should only be replaced with a 3.15A slow blow fuse.

The following table summarises the internal Earth interconnection and isolation.

| Circuit | Description | |
|--------------------------------------|--|--|
| Chassis | Bonded to Earth-Ground | |
| DMX512 input module | Type | Optically isolated |
| | Pin 1 | Isolated |
| | Shell | The connector shell is connected to chassis |
| Ethernet input module | Type | Transformer isolated |
| | Screen | Connects to Earth-Ground via 75 Ohm resistance & 100 pF capacitance, as specified in IEEE standard |
| Base unit DMX512 outputs (mono, duo) | Type | Ground referenced |
| | Pin 1 | Connected to Internal Logic Ground |
| | Shell | The connector shell is connected to chassis |
| Base unit DMX512 outputs (iso) | Type | Isolated |
| | Pin | Isolated |
| | Shell | The connector shell is connected to chassis |
| Internal Logic Ground | Connects to Earth-Ground via 10 Ohm resistance | |

versaSplit outputs

All the versaSplit carrier units feature DMX/RDM outputs, which may use XLR3, XLR5 or XLR8 (Ethercon RJ45) connectors. For versaSplit duo, each output connector has a switch to the lower left that defines which input module, A or B, is connected. versaSplit iso features individually isolated outputs. Each output is independently buffered and can drive up to 32 DMX devices. It is not necessary to terminate any unused outputs.

extreme models

versaSplit extreme models offer all the features of the standard product, while additionally providing surge protection. This feature is aimed at protecting the product and connected equipment against voltage surges of the type generated by lightning. The protection is sacrificial which means that after a certain number of protection events, the protection circuitry will be destroyed (see relevant product datasheet).

DMX/RDM input modules

When versaSplit is fitted with one (or two) DMX/RDM input modules, it acts as a one (or two) input splitter / data fixer.

The XLR modules feature a male input and female loop-through connector. The latter must be terminated if not being used.



3-pin male XLR input



5-pin male XLR input

The Ethercon RJ45 module should be used with Cat5 cable.



Ethercon RJ45 input

The inputs on all 3 types of modules are optically isolated from the outputs and mains earth. This isolation offers protection from potentially dangerous high voltage accidents. Also it can eliminate potential earth/ground differential issues as the input is not electrically connected to any of the outputs.

| XLR Pin (convention) | Function | Colour | RJ45 Pin | Cable Colour |
|----------------------|------------|--------|----------|---------------------|
| 1 | Ground | Black | 7 & 8 | White/Brown & Brown |
| 2 | Data - | Blue | 2 | Orange |
| 3 | Data + | Red | 1 | White/Orange |
| 4 | Aux Data - | | 6 | Green |
| 5 | Aux Data + | | 3 | White/Green |

Split/Fix Mode

Normal splitter operation is achieved by setting the switch next to the input connector to 'Split'. In splitter mode, the outputs operate as bi-directional RDM ports and all DMX data received is passed onto the outputs.

Alternatively, set the switch to 'Fix' if you are experiencing product compatibility problems. Unfortunately, there are numerous products on the market which will not accept the wide range of legal DMX timings and data. Fixer mode attempts to clean-out any unusual or non-standard timing and data before sending to the output. This includes stripping out all non-zero start codes (including RDM), forcing a 512-channel footprint and calming any timing jitter.

The detailed fix specification is as follows:

- Accepts and corrects break in range 56 μ s – 1000 μ s and outputs 250 μ s
- Accepts and corrects MaB in range 5 μ s – 1000 μ s and outputs 30 μ s
- Accepts and corrects MbB in range 0 μ s – 1000 μ s and outputs 30 μ s
- Accepts channel count 1 – 512 and outputs 512
- Accepts refresh period from 23 ms – 1000 ms and outputs 30ms
- Filters out multiple consecutive breaks
- Re-times bytes of 1 stop bit to 2 stop bits
- Filters out all non-zero start code packets
- Re-times digital signal

LED indicators

The DMX/RDM input modules feature a set of LED indicators: Iso, DMX and Pow/Fix. The meaning of each is as follows:

- Iso
 - Green: the input isolation DC supply is working
 - Red: the input isolation DC supply is not working (indicating that the circuitry has probably been electrocuted)

- DMX
 - Off: no data received
 - Green: DMX and RDM received
 - Yellow: DMX only received
- Pow/Fix
 - Green: power on
 - Red (split mode): data error or collisions detected
 - Red (fix mode): data fixing is occurring

If using two DMX/RDM modules in versaSplit duo, each module can be set independently to splitter or fixer mode. The individual outputs should be switched to A or B depending on which mode is required.

CRMX wireless DMX input module

When versaSplit is fitted with one (or two) CRMX wireless DMX input modules, it acts as a one (or two) input splitter / data fixer.

Conceptually, the functionality is similar to the DMX/RDM modules. Where it differs is in the method of DMX delivery (radio); also, RDM is not currently supported.

The radio link should activate a few seconds after the transmitting device is set to connect. To deactivate the radio link, press and hold the 'Link' button on the input module for 3 seconds.

If using two CRMX wireless DMX modules in versaSplit duo, each module can be set independently to splitter or fixer mode. The individual outputs should be switched to A or B depending on which mode is required.



CRMX wireless DMX input module with antenna

CRMX wireless DMX input module without antenna

LED indicators

The CRMX wireless DMX module features two sets of LED indicators.

On the left hand side, the strength of the radio signal is indicated by green lights for intensities of 20% and upwards. If the strength drops below 10%, the bottom light turns red.

On the right hand side, there are 4 separate LED indicators:

- Status (refers to CRMX signal)
 - Off: not linked to transmitter
 - Green fast flash: linked but transmitter not active
 - Green slow flash: active radio link but no DMX data
 - Green: active with DMX present
- Link - Green: transmitter active
- DMX - Yellow: DMX present
- Pow/Fix
 - Green: power on
 - Red (split mode): data error or collisions detected
 - Red (fix mode): data fixing is occurring

Ethernet input module B

Ethernet input module B enables versaSplit to perform ethernet to DMX&RDM conversion. The module requires Cat 5 cable or better.



- Art-Net, sACN, RDMnet LLRP
- 10/100BaseT
- LED indicators
- RJ45 Ethercon connector

LED indicators

The module features 3 LED indicators labelled Status, Net and DMX. These give different informational signals depending on whether the product is booting up or in operational mode.

The meanings are explained below.

During boot-up

- Status
 - Slow flashing green (1Hz) = booting normally
 - Slow alternating green/red (1Hz) = factory start (settings cleared)

During operation

- Status
 - Static green = powered, normal operation
 - Fast flashing green (5Hz) = identify
 - Occulting green = remote programming command received
 - Static red = fault condition
 - Fast alternating green/red (5Hz) = product is not commissioned
- Net
 - Yellow = network link established
 - Green = Art-Net or sACN detected
- DMX
 - Green = Data activity
- All indicators
 - Off = mute command received

Configuration

Configuration is achieved via the internal web server or via DMX-Workshop.

Web server

To configure via the internal web-server, either type in the IP address of the product or, if your web-browser supports NetBios, then enter the name: VersaEtherB. To find the IP address, use DMX-Workshop.

A screenshot of the internal web server and an explanation of the settings follow:

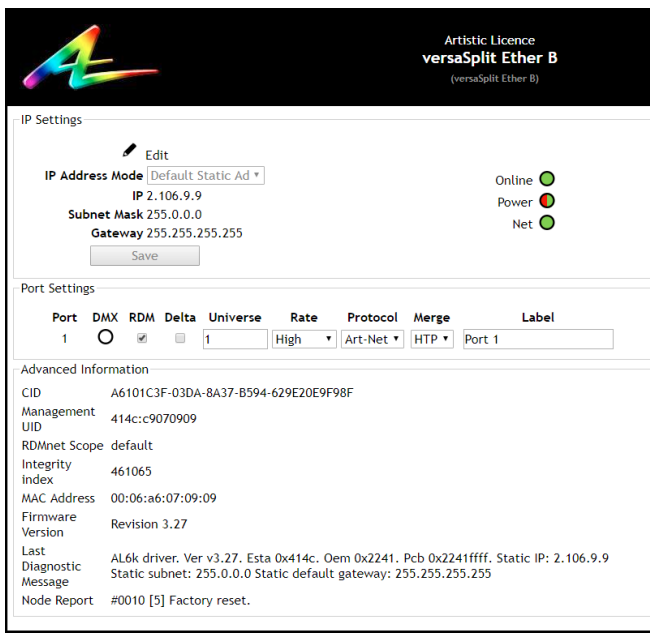

Figure: versaSplit ETHB module internal web server

Universe Addressing

The universe (Port Address) is used to uniquely identify the DMX data on the network.

Art-Net allows universe numbers in the range 0-32767.

sACN allows universe numbers in the range 1-65535.

For the avoidance of cross-protocol confusion, users are advised to number universes from 1.

IP Settings

The IP settings for the product are displayed in the top section of the screen. The Edit control allows the static IP, subnet mask and gateway to be configured. DHCP operation can be selected via DMX-Workshop.

The indicator meanings are as follows:

- Online: Green = live connection between browser & product; Red = connection lost
- Power: Green = powered; Flashing green = Identify; Red = Fault
- Net: Yellow = Link; Green = Art-Net or sACN activity

Port Settings

The settings for each DMX port can be configured via the web-browser as follows:

- Port: The DMX port number
- DMX: Green shows changing data
- RDM: Tick to enable RDM
- Delta: Tick to enable delta transmission (DMX frames are only sent when network data changes)
- Universe: Set the universe (port address) for this output (see note in red, opposite)
- Rate: Sets the DMX refresh rate:
 - High = 24 ms frame time
 - Medium = 32 ms frame time
 - Slow = 48 ms frame time
- Protocol: Select either Art-Net or sACN control over this output
- Merge: Select HTP or LTP merge when 2 controllers send data to this port (for more information, see 'Merging' section on page 11).
- Label: Editable field for port name

DMX-Workshop

DMX-Workshop™ is a fully featured network management, analysis, configuration and diagnostics tool for lighting networks. You can download the free software from our [website](#).

When versaSplit EthB is connected to a computer running DMX-Workshop, it should be detected and displayed as an Art-Net node (click the 'Node List' tab to verify this). The node can be expanded to show the configuration and DMX output information, as shown below.

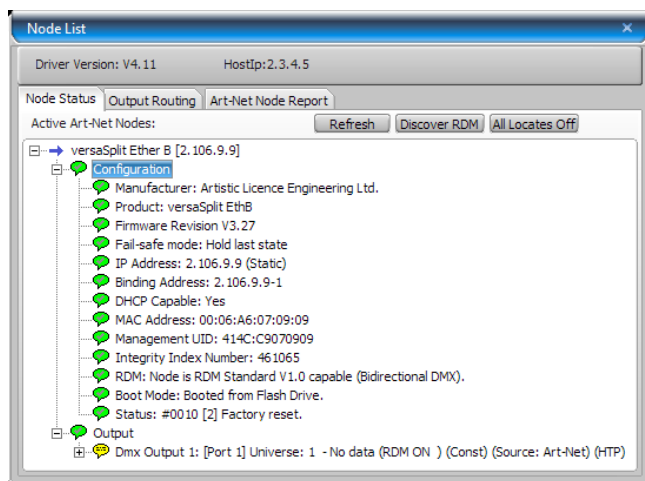

Figure: versaSplit EthB as viewed in DMX-Workshop

Right-clicking on any entry brings up a menu that offers various functionality:

- The 'Configure Node' option enables configuration of the universe number (port address), protocol (Art-Net or sACN), sACN priority, product name and port labels.
- 'Copy to clipboard' enables all the node information to be pasted into a support request email.
- 'Merge Controls' (selectable only on individual DMX outputs) enables the choice of LTP (latest takes preference) or HTP (highest takes preference) merge modes.
- 'Indicators' enables selection of normal, identify or mute for the LED indicators. Normal is the default behaviour, identify causes the power LED to flash, and mute turns off all the LEDs.

- 'RDM Devices' offers options for device discovery and configuration.
- 'Advanced' leads to 'Programme Upload' and 'Configure IP Address and DHCP' as described below.

IP Address Configuration

Choosing the 'Configure IP Address' in the 'Advanced' menu brings up a window that shows the IP and Subnet Mask.

The IP uniquely identifies any nodes or controllers on a network, while the Subnet Mask defines which part of the IP represents the network address and which part represents the node address. For example, a Subnet Mask of 255.0.0.0 means that the first byte of the IP defines the network address and the remaining 3 bytes define the Node address.

By default, the product has a static IP address in the range 2.x.x.x. There are situations in which the user may wish to change this - for example, a 192.168.x.x address is generally used in office environments.

A useful additional feature is the ability to enable automatic IP address allocation on networks controlled by a DHCP server (check the 'Enable DHCP' box to activate).

Merging

versaSplit ethB is able to merge two streams of data to a DMX output. Depending on the settings, merge can operate as HTP/LTP or Priority.

In HTP (highest takes precedence), the levels of each channel in the two streams are compared and the highest value is used.

In LTP (latest takes precedence), the levels of each channel in the two streams is compared to the output; if there is a change, that level is output.

In Priority, the sACN Priority field defines which universe will be output.

Art-Net

If two streams from different IP addresses are directed to the same Port-Address, merging will occur. If more streams are directed to the same Port-Address, they will be ignored.

sACN

Merging can operate with both unicast and multicast data.

If two streams from different IP addresses are directed to the same universe, the priority field is checked and the stream with the highest priority is output. If the priority field in both streams is identical, merging will occur.

If additional stream(s) are directed to the same universe, any additional stream with higher priority will take precedence. If the priority is identical to the merging streams, it will be ignored.

Please refer to Application Note “0130 Gateway merging” for more information.

<https://artisticlicence.com/application-notes/>

Application Diagram

Example 1

versaSplit duo with 2 DMX/RDM XLR5 input modules and XLR5 outputs (vSplit duo xlr5-5-xlr5). Here, versaSplit is used simultaneously as a data splitter and fixer. Outputs 1 & 3 are set to input module A, and outputs 6 & 8 are set to input module B.

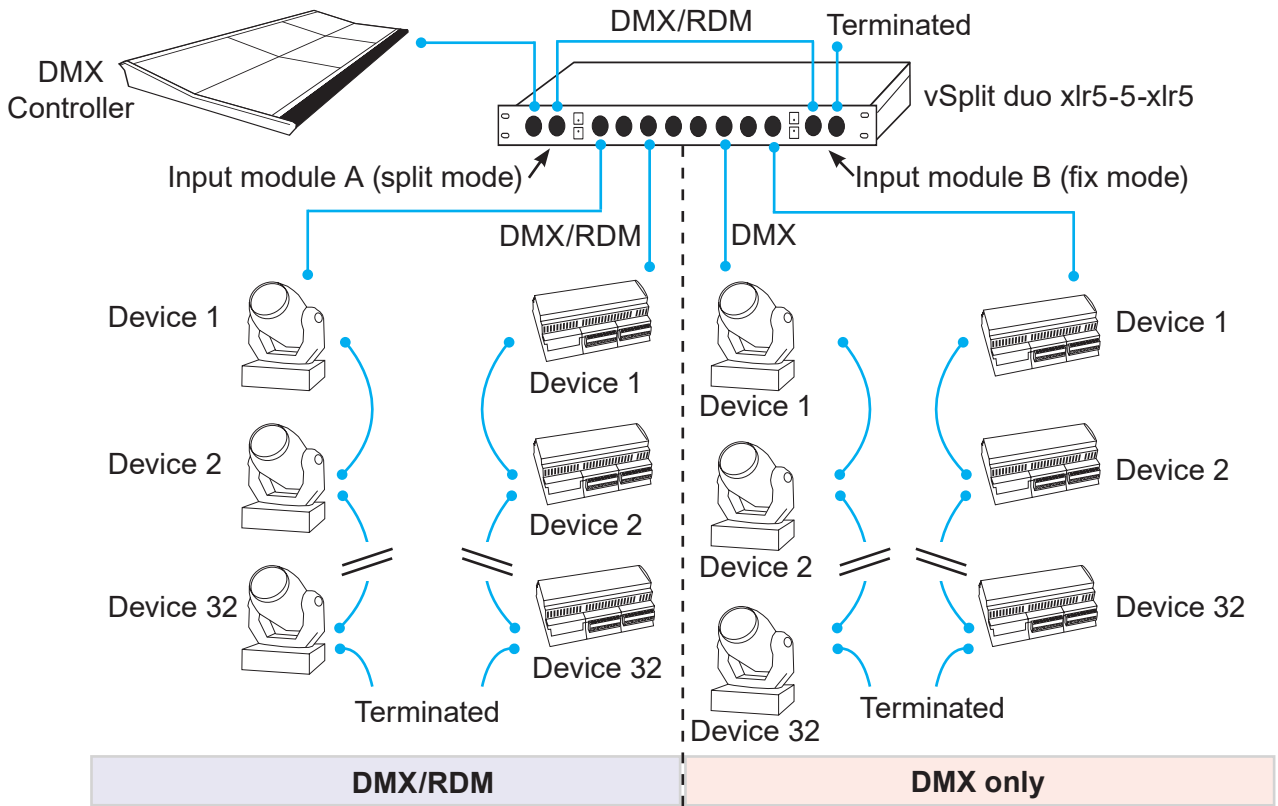

Example 2

versaSplit duo with one CRMX wireless DMX input module and one ethernet input module b, with XLR5 outputs (vSplit duo crmx-5-ethb). A DMX radio transmitter controls a set of moving heads. The CRMX wireless DMX module on input A (split mode) forms the interface, sending the data to output 4. Concurrently, a Colour-Tramp controller is running a show on an LED pixel product driven by intelligent power supplies (such as Multichrome D1). The ethernet module on input B converts the Art-Net into DMX/RDM data, which is sent to outputs 5, 6, 7 and 8.

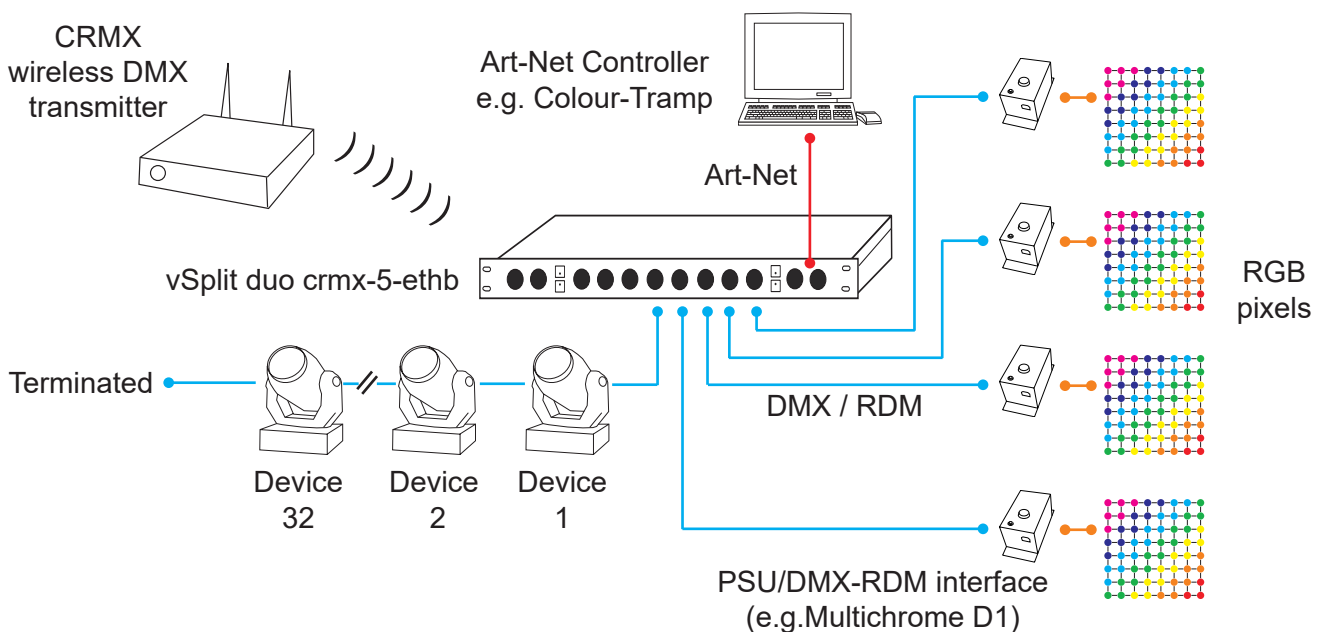

Ordering information

Because so many product configurations are possible with versaSplit, only a few popular models are available as stock; the rest are built to order. The part codes for the stock items are as follows:

- vSplit **mono xlr5-5**
- vSplit **mono crmx-5**
- vSplit **mono xlr8-8**
- vSplit **iso xlr5-5**
- vSplit **iso xlr8-8**
- vSplit **duo xlr5-5-xlr5**

The part code is constructed as follows:

vSplit **carrier unit** **input A module** - **output connectors** - **input B module**

- The carrier units are: mono, iso, duo
- The input modules are: xlr3, xlr5, xlr8, crmx, ethb, b (for blanking plate) and x (no module fitted)
- The possible output connectors are 3, 5, and 8 (denoting XLR3/XLR5/XLR8)

Previous customers should please note that:

- vSplit mono xlr5-5 replaces Rack-Split RDM, which has been discontinued.
- vSplit iso xlr8-8 replaces Iso-Split RDM, which has been discontinued.
- vSplit duo xlr5-5-xlr5 replaces Duo-Split RDM, which has been discontinued.

versaSplit carrier unit specification

| | |
|---|--|
| Mechanical <ul style="list-style-type: none">• Housing: 19" 1U rack enclosure• Material: metal• Overall dimensions: 1RU (H) x 19" (W) x 227 mm (D)• Weight: 2.28 kg• Mounting: desktop or 19" rack (using supplied rack ears)• Country of manufacture: UK | DMX512 Outputs <ul style="list-style-type: none">• Output mode: ground referenced (mono & duo), isolated (iso)• Output ESD protection (mono/iso): 12 kV• Output ESD protection (duo): 15 kV• Output voltage protection (mono/iso): +/-80 V• Output voltage protection (duo): All outputs protected against continuous connection to 425 VAC (self-healing)• Output surge protection (extreme variants only):<ul style="list-style-type: none">- GDT conforming to IEC61643-311 (sacrificial)- Max Impulse Discharge Current: 30,000A (8/20uS) 1 operation; 20,000A (8/20uS) 10 operations; 20A (10/1000uS) 1500 operations |
| Environmental <ul style="list-style-type: none">• Operating temperature: 0°C to 40°C• Storage temperature: -10°C to +50°C• Operating relative humidity (max): 80% non-condensing• IP rating: IP20 indoor use only• Certification: CE, WEEE, RoHS• Warranty: 2-year (return to base) | Control <ul style="list-style-type: none">• Output Protocols: DMX512, DMX512 (1990), DMX512-A, RDM V1.0 (E1.20 - 2010) |
| Power & Electrical <ul style="list-style-type: none">• Input voltage: 90-250 VAC• Input connector: IEC C13 male• Input power (max): 250 W• Duty cycle: 100% @ 25°C• Mains fuse: 3.15A slow blow | Data Connections <ul style="list-style-type: none">• 3-pin female XLR or 5-pin female XLR or 8-pin XLR Ethercon (10 no. for mono & iso; 8 no. for duo) |

| |
|--|
| Configuration <ul style="list-style-type: none"> Switch to A/B input module on each output (versaSplit duo only) |
| Package Contents <ul style="list-style-type: none"> versaSplit mono/iso/duo carrier unit Input module(s) as ordered IEC mains lead & rack-ears |

Input module specification

DMX/RDM module

| |
|--|
| Mechanical <ul style="list-style-type: none"> Material: metal Overall dimensions: 44 mm (H) x 76 mm (W) x 76 mm (D) Weight: 0.12 kg Country of manufacture: UK |
| Power & Electrical <ul style="list-style-type: none"> Input voltage: 3.3 V |
| DMX512/RDM Input <ul style="list-style-type: none"> Input mode: Optically isolated Input ESD protection: 12 kV Input voltage protection: +/- 80 V |
| Control <ul style="list-style-type: none"> Input Protocols: DMX512, DMX512 (1990), DMX512-A, RDM V1.0 (E1.20 - 2010 ESTA Standard) |
| Data Connection <ul style="list-style-type: none"> XLR3 male input (1 no.) plus XLR3 female DMX loop-through (1 no.) OR XLR5 male input (1 no.) plus XLR5 female DMX loop-through (1 no.) OR XLR8 Ethercon input (1 no.) plus XLR8 Ethercon DMX loop-through (1 no.) |
| LED Indication <ul style="list-style-type: none"> Isolation / DMX & RDM Activity / Power & Fix status |
| Configuration <ul style="list-style-type: none"> Split/Fix slide selector |
| Ordering Info <ul style="list-style-type: none"> Product code: vSplit XLR3 / XLR5 / XLR8 |

CRMX wireless DMX module

| |
|--|
| Mechanical <ul style="list-style-type: none"> As DMX/RDM module |
| Power & Electrical <ul style="list-style-type: none"> Input voltage: 3.3 V |
| Control <ul style="list-style-type: none"> CRMX wireless DMX |
| Data Connection <ul style="list-style-type: none"> Radio antenna |
| LED Indication <ul style="list-style-type: none"> Signal strength bar graph CRMX wireless DMX status / Radio link / DMX Activity / Power & Fix status |
| Configuration <ul style="list-style-type: none"> Split/Fix slide selector Link push-button for CRMX wireless DMX configuration |
| Ordering Info <ul style="list-style-type: none"> Product code: vSplit CRMX |

Ethernet module B

| |
|---|
| Mechanical <ul style="list-style-type: none"> As DMX/RDM module |
| Power & Electrical <ul style="list-style-type: none"> Input voltage: 3.3 V |
| Ethernet input <ul style="list-style-type: none"> Type: 10/100BaseT (auto-selected) Isolation: 1 kV |
| Ethernet protocols <ul style="list-style-type: none"> Art-Net, sACN, RDMnet LLRP |
| Data Connection <ul style="list-style-type: none"> 8-pin XLR Ethercon (1 no.) |
| LEDs & Configuration <ul style="list-style-type: none"> Status / Net / DMX Web-browser, DMX Workshop |
| Ordering Info <ul style="list-style-type: none"> Product code: vSplit ETHB |

CE Compliance



versaSplit is CE compliant

Warranty

All products are covered from date of purchase by a two-year return to base warranty.

By return to base, we mean that the customer is responsible for all costs of transport to and from Artistic Licence.

Returns will not be accepted without prior authorisation. In order to discuss a request to return goods, please email:

Sales@ArtisticLicence.com

Compliance

All Products manufactured or sold by Artistic Licence Engineering Ltd are fully compliant with the appropriate CE and RoHS regulations. Product specific information is available on request.

Waste Electrical & Electronic Equipment (WEEE)

Artistic Licence is a member of a WEEE compliance scheme and will happily recycle any of our products that you, at your expense, return to us.



Artistic Licence

The Mould Making Workshop
Soby Mews
Bovey Tracey
TQ13 9JG
United Kingdom

Telephone +44 (0) 20 8863 4515

Email: Sales@ArtisticLicence.com

Web: www.ArtisticLicence.com

Support@ArtisticLicence.com

Due to our policy of continuing product improvement specifications are subject to change without notice

